



Catalogo Prodotti 2019





Simbologia

Indice



EHS (Ergonomic Handling System)
Sistema che caratterizza i comandi di alcune macchine, garantendo facilità di utilizzo, riduzione degli sforzi e massima semplificazione per l'utilizzatore.



Gasoline
Motore con alimentazione a benzina.



Diesel
Motore con alimentazione a gasolio.



Original accessories and spare parts
Marchio di qualità che contraddistingue i ricambi e gli accessori originali di Emak. Progettati secondo i più severi standard di qualità garantiscono un miglior funzionamento della macchina e una vita utile più lunga.

	Struttura aziendale	4	
	Motozappe	8	
	Motocoltivatori	20	
	Trinciasarmenti	56	
	Falciatrici	62	
	Motocarroie	92	



La nostra Vision

“Soluzioni innovative con il miglior valore per il cliente”

Intendiamo essere, nello sviluppo, nella produzione e distribuzione di macchine, componenti e accessori per il giardinaggio, l'agricoltura, l'attività forestale e l'industria, uno dei player di riferimento a livello mondiale nell'offerta di prodotti e servizi innovativi, che rendano efficiente e piacevole l'attività per i nostri clienti consumer e professionali, garantendo loro il miglior valore.



La Struttura

Il **Gruppo Emak** è attivo nello sviluppo, produzione e commercializzazione a livello mondiale di un'ampia gamma di prodotti per tre segmenti di business:

Outdoor Power Equipment

- prodotti destinati al giardinaggio, all'attività forestale e all'agricoltura quali decespugliatori, tagliaerba, trattorini, motoseghe, motozappe e motocoltivatori.

Pompe e High Pressure Water Jetting

- prodotti per l'agricoltura quali pompe centrifughe e a membrana per l'irrorazione e diserbo;
- prodotti per l'industria, tra i quali sono compresi le pompe per l'industria e gli impianti ad alta ed altissima pressione;
- prodotti per il lavaggio (cleaning), ossia idropultrici professionali e semiprofessionali, macchine lava-asciuga pavimenti ed aspiratori.

Componenti e Accessori

- prodotti quali filo e testine per decespugliatori, accessori per motoseghe, pistole, valvole ed ugelli per idropultrici e per applicazioni agricole, precision farming (sensori e computer).

Il Gruppo impiega complessivamente circa **2.000** dipendenti e realizza un fatturato di oltre **400 milioni di euro**.

Le Divisioni e la Gamma Prodotti

Outdoor Power Equipment

Gamma prodotti



Pompe e High Pressure Water Jetting

Gamma prodotti



Componenti ed Accessori

Gamma prodotti

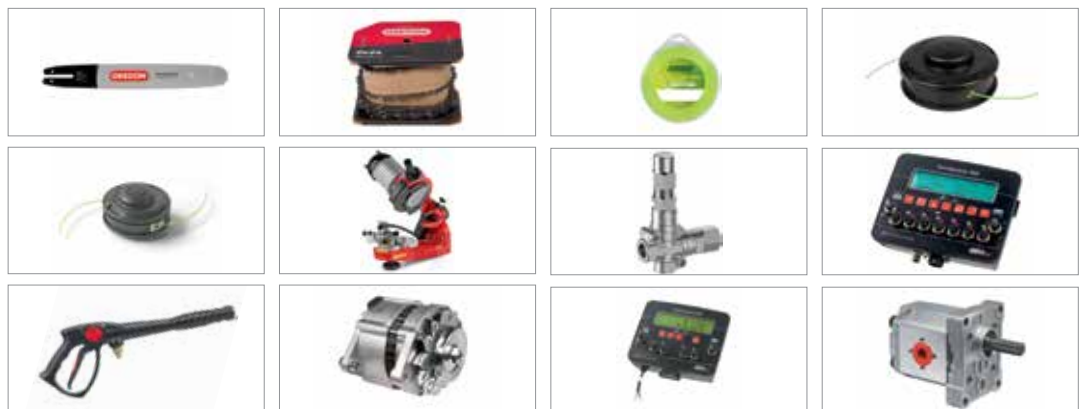

La nostra Passione

Il verde di **Emak** è un verde certezza, di **qualità**, di **innovazione**, di **completezza**. È un verde fatto di **cura** e di **rispetto**, di **passione** e di **progettazione**. Per questo **Emak**, attraverso i suoi marchi **Efco**, **Oleo-Mac**, **Bertolini** e **Nibbi**, rappresenta un punto di riferimento per professionisti e hobbisti nella manutenzione del verde. Una **passione** da oltre 50 anni tutta **italiana**. Ad ognuno la sua **Emak**.



La Struttura

Emak opera nel segmento **Outdoor Power Equipment** attraverso **10** società attive nello sviluppo, produzione e commercializzazione di **prodotti per il giardinaggio, l'attività forestale e piccole macchine per l'agricoltura**, quali decespugliatori, rasaerba, trattorini, motoseghe, motozappe e motocoltivatori.

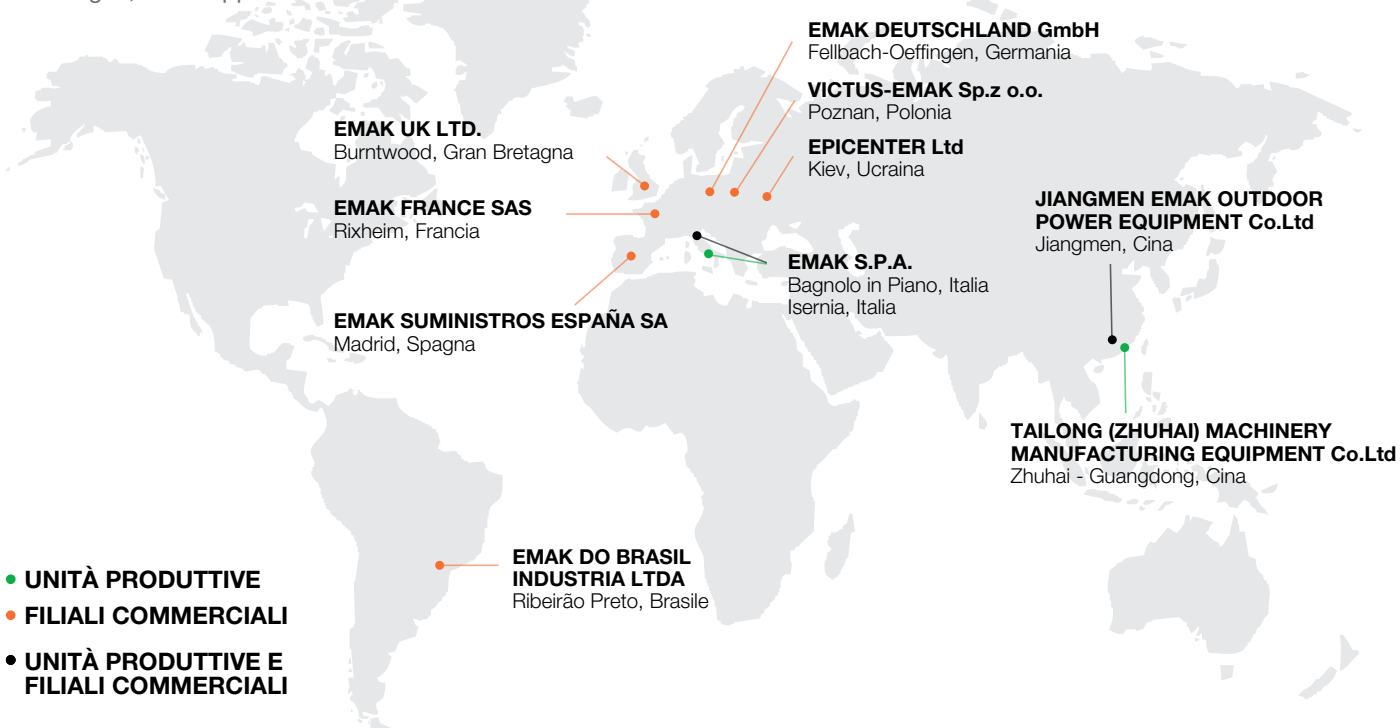

I Numeri

4	marchi commerciali
4	unità produttive
8	filiali commerciali estere
~800	dipendenti
~170	mln di € di fatturato
150	distributori
115	paesi raggiunti
22	famiglie prodotto
250	modelli



Outdoor Power Equipment

Le Certificazioni

Yes, we care.

Siamo stati i primi al mondo nel nostro settore ad aver conseguito certificazioni in tre ambiti fondamentali della sostenibilità di impresa quali:

- Etica
- Ambiente
- Qualità

We care

Certified Quality Ethics Environment

La Gamma Prodotti e Accessori

B BERTOLINI

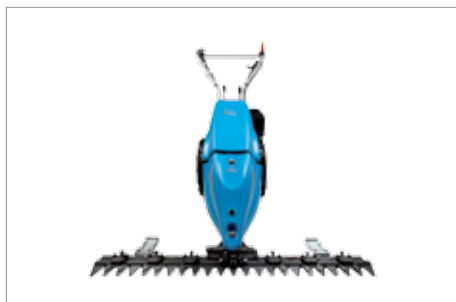

Il risultato dell'articolato processo di sviluppo dei prodotti di Bertolini è una **gamma completa e in costante aggiornamento di macchine per la lavorazione del terreno in agricoltura e la cura di orti e giardini** in grado di rispondere alle esigenze di ogni tipologia di utente. Prodotti diversi a seconda dell'impiego a cui sono destinati, ma accomunati dagli elevati standard qualitativi in termini di prestazioni, affidabilità, confort e sicurezza.

Home-plus



Home-plus

Gamma di macchine per il consumatore privato, per attività di cura e pulizia del giardino, lavori su siepi e piccoli fusti e per tutte le attività di bricolage. Sono caratterizzate da leggerezza e da forme compatte per semplificare al massimo il lavoro dell'operatore. Semplici da avviare, da utilizzare e di facile manutenzione, sono gli strumenti ideali per svolgere nel modo più rapido e preciso gli interventi intorno a casa.

Tough-tech



Tough-tech

Robuste ed affidabili, queste macchine sono pensate per un utilizzo intenso e frequente in ambito rurale, per attività di sfalcio di aree incolte, di potatura e di taglio di legna da ardere e per interventi di irrigazione e disinfestazione di coltivazioni. Progettate con soluzioni pensate per durare nel tempo garantiscono allo stesso tempo resa elevata e massima durata nel tempo.

Sharp-pro



Sharp-pro

Veri e propri strumenti di lavoro quotidiano per il professionista, queste macchine si distinguono per robustezza dei particolari, elevate prestazioni e massima affidabilità nel tempo. Grazie a materiali specifici sono studiate per garantire costanza qualitativa anche a fronte dei lavori più intensi e prolungati, nelle attività di interventi forestali e di pulizia di aree incolte o sottobosco.

Le specialiste della lavorazione della terra.
Potenti e resistenti sulle grandi superfici,
pratiche e affidabili anche in orti
e giardini privati: un'ampia gamma
per tutte le esigenze.



Motozappe

PRIVATO

**020**

INTENSIVO

**205 S****NOVITÀ**

PROFESSIONALE

**218****NOVITÀ****155****NOVITÀ****195 S****NOVITÀ**

DATI TECNICI



cambio



potenza



fresa

Motozappa per uso privato

020



Ideale per piccoli orti con necessità di manutenzione periodica e attività diversificate quali la sminuzzatura del terreno in preparazione della semina, la creazione di solchi per piantumazione e altre operazioni come arieggiatura del terreno e pulizia di selciati.



Stegole ripiegabili per rispondere alle esigenze di rimessaggio e trasporto (alloggiamento in baule di automobili).



Robusta scatola in alluminio con ingranaggi e vite senza fine che garantisce massima resistenza agli urti (sassi, muretti, recinzioni) e alle sollecitazioni.



La protezione frontale del motore permette di reclinare la macchina in verticale in garage o nel ripostiglio attrezzi, con un evidente risparmio di spazio.

020

Alimentazione	Motore	Modello	Cilindrata	Potenza	Avviamento	Codice
gasoline	POWERED by HONDA	GX 25 OHV	25 cm ³	0,8 HP	autoavvolgente	68609130E5

Focus accessori



Spazzola a rulli
Codice **68602002**

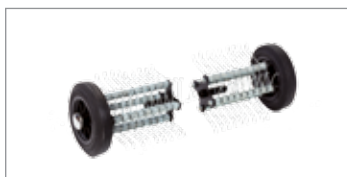

Arieggiatore
Codice **68602003**



Vomere
Codice **68602004**



Cambio:

1 velocità (1 avanti)

Giri fresa con motore 3600 giri/min:

162

Dimensioni (mm)

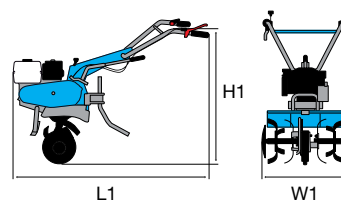

L1	1250
H1	1000
W1	300

Trasmissione	in alluminio con vite senza fine
Frizione	centrifuga
Stegole	reversibili
Fresa	30 cm
Presa di forza	no
Sperone	sì
Gancio di traino	no
Ruotino di trasferimento	sì
Peso	14 kg

Motozappa per uso privato

155

NOVITÀ

Ideale per utenti privati che devono preparare orti o aiuole in previsione della semina, questo modello si caratterizza per una eccellente combinazione di maneggevolezza e facilità d'uso.



Ruota di trasferimento posteriore utile per lo spostamento della macchina.



Regolatore di velocità con sistema on-off integrato e leva di comando fresa posizionate a portata di mano.



Fresa a tre elementi per lato da 46 cm restringibile a 32-22 cm.

155

Alimentazione	Motore	Modello	Cilindrata	Potenza	Avviamento	Codice
gasoline	Emak	K 300 H OHV	80 cm ³	2,4 HP	autoavvolgente	68569001E5

Cambio:
1 velocità (1 avanti)

Giri fresa con motore 3400 giri/min:

159

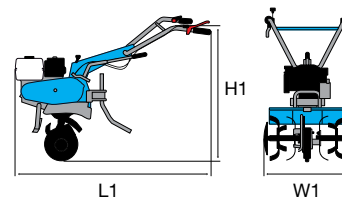
Dimensioni (mm)

L1	1150
H1	1000
W1	460-320-220

Trasmissione	a catena
Frizione	a cinghia con tenditore
Stegole	regolabili verticalmente 3 posizioni
Fresa	46 cm, restringibile a 32-22 cm
Presa di forza	no
Sperone	sì
Gancio di traino	no
Ruotino di trasferimento	sì
Peso	27 kg

Motozappa per uso privato

195 S

NOVITÀ

Ideale per utenti privati che devono preparare terreni soffici in previsione della semina, questo modello si caratterizza per una eccellente combinazione di maneggevolezza e semplicità di utilizzo.



Ruota di trasferimento anteriore utile per il trasporto della macchina. È facilmente ribaltabile in altezza senza attrezzi per agevolare il lavoro sul terreno.

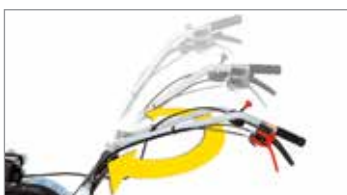

Stegole regolabili orizzontalmente e verticalmente, permettono all'operatore di lavorare con una postura corretta.



Fresa a tre elementi per lato da 82 cm con dischi laterali di protezione.

195 S

Alimentazione	Motore	Modello	Cilindrata	Potenza	Avviamento	Codice
gasoline	Emak	K 800 HT OHV	182 cm ³	5,7 HP	autoavvolgente	68599001E5

Focus accessori



Assolcatore
Codice **69209081**
(necessita portattrezzi **69209087**)



Aratro
Codice **69209082**
(necessita portattrezzi **69209087**)



Scavapatate
Codice **69209083**
(necessita portattrezzi **69209087**)



Portattrezzi
Codice **69209087**



Coppia ruote metalliche
Codice **69209084**



Cambio:

2 velocità (1 avanti + 1 retro)

Giri fresa con motore 3400 giri/min:

159 **1** **1R** 66

Dimensioni (mm)

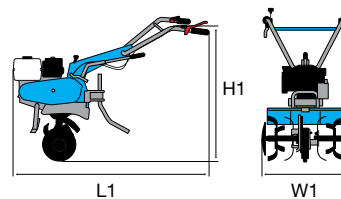

L1	1400
H1	800
W1	820-550

Trasmissione	a catena
Frizione	a cinghia con tenditore
Stegole	regolabili verticalmente e orizzontalmente
Fresa	82 cm, restringibile a 55 cm, con dischi laterali di protezione
Presa di forza	no
Sperone	sì
Gancio di traino	sì
Ruotino di trasferimento	sì
Peso	57 kg

Motozappa per uso intensivo

205 S

NOVITÀ

Ideale per utenti privati esigenti che devono preparare terreni in previsione della semina. Questo modello si caratterizza per avere due velocità in avanti e una retromarcia, una eccellente combinazione per le lavorazioni più difficili.



Selettore marce esterno, pratico ed ergonomico. Portattrezzi integrato e sperone registrabile in profondità.



Stegole regolabili verticalmente ed orizzontalmente tramite una comoda leva a manubrio, permettono all'operatore di lavorare con una postura corretta.



Fresa da 85 cm (restringibile a 60-35 cm), coltelli maggiorati e dischi di protezione laterali.

205 S

Alimentazione	Motore	Modello	Cilindrata	Potenza	Avviamento	Codice
gasoline	Emak	K 800 HC OHV	182 cm ³	5,7 HP	autoavvolgente	68589010E5

Focus accessori

	Assolcatore Codice 69209081
	Aratro Codice 69209082
	Scavapatate Codice 69209083
	Coppia ruote metalliche Codice 69209116
	Coppia ruote gommate 3.50-6\" Codice 69209089
	Coppia ruote gommate 3.50-8\" Codice 69209114



Cambio:

3 velocità (2 avanti + 1 retro)

Giri fresa con motore 3400 giri/min:

83	1	1R	62
114	2		

Dimensioni (mm)

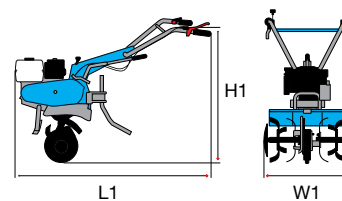

L1	1630
H1	1050
W1	850-600-350

Trasmissione	ad ingranaggi in bagno d'olio e catena
Frizione	a cinghia con tenditore
Stegole	regolabili verticalmente e orizzontalmente
Fresa	85 cm, restringibile a 60-35 cm, con dischi laterali di protezione
Presa di forza	no
Sperone	sì, regolabile in profondità
Gancio di traino	sì, con portattrezzi integrato
Ruotino di trasferimento	sì
Peso	63 kg

Motozappa professionale

218

NOVITÀ



Modello progettato per le esigenze professionali degli agricoltori e dei manutentori del verde. La trasmissione diretta ad ingranaggi sull'albero motore lo rende resistente alle sollecitazioni durante il lavoro in terreni duri.



Trasmissione diretta ad ingranaggi sull'albero motore.

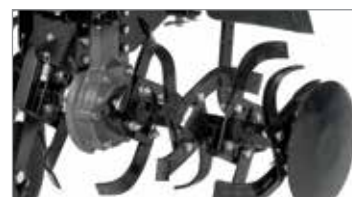

Estrema versatilità grazie al cambio a 4 velocità (3 avanti + 1 retro), che consente di lavorare il terreno con la stessa efficacia a seconda della durezza e della consistenza.



Trasmissione ad ingranaggi in bagno d'olio, resistente e con ridotta manutenzione.

218

Alimentazione	Motore	Modello	Cilindrata	Potenza	Avviamento	Codice
gasoline	Emak	K 900 HR OHV	252 cm ³	7,0 HP	autoavvolgente	68579001E5S1
diesel	Emak	K 7000 HDR	349 cm ³	6,3 HP	autoavvolgente	68579002E5S1

Focus accessori



Assolcatore
Codice **69209081**



Aratro
Codice **69209082**



Scavapatate
Codice **69209083**



Coppia ruote metalliche
Codice **69209122**



Coppia ruote gommata 3.50-8"
Codice **69209123**



Cambio:

4 velocità (3 avanti + 1 retro)

Giri fresa con motore 3600 giri/min:



Dimensioni (mm)

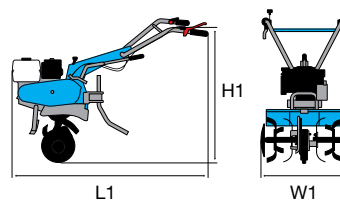

L1	1500 (gasoline) 1700 (diesel)
H1	1100
W1	1000-820-600

Trasmissione	ad ingranaggi in bagno d'olio
Frizione	multidisco in bagno d'olio
Stegole	regolabili verticalmente e orizzontalmente
Fresa	100 cm, restringibile a 80-60 cm, con dischi laterali di protezione
Presa di forza	sì, 3600 giri/min
Sperone	sì, regolabile in profondità
Gancio di traino	sì, con portattrezzi integrato
Ruotino di trasferimento	sì (versione diesel con cavalletto frontale)
Peso	96 kg con motore a benzina - 131 kg con motore diesel

Potenti e affidabili, maneggevoli,
reversibili e plurifunzionali
rappresentano la soluzione ideale
per ogni tipo di lavoro
in ogni stagione.



Motocoltivatori

PRIVATO



400



401 S



INTENSIVO



405 S



407 S



413 S



PROFESSIONALE



417 S



418 S



DATI TECNICI



cambio



freni



potenza



blocco differenziale



inversore



semiassi con riduttori

OPTIONAL



fresa



spazzolone



aratro



turbina



trinciasarmenti



sfalciaerba



pala



barra falciante



carrello

Motocoltivatore per uso privato

400



Ideale per utenti privati che dispongono di piccoli orti e giardini con la necessità di manutenzione periodica del terreno in preparazione della semina, anche in condizioni particolarmente difficili. La fresa di lavoro ha la particolarità di ruotare nella direzione opposta a quella di avanzamento delle ruote in modo tale da garantire all'operatore il massimo controllo del motocoltivatore, combinato ad una sensibile riduzione delle vibrazioni percepite dall'operatore.



Fresa da 50 cm controrotante che facilita il lavoro su terreni particolarmente difficili.



Ruote di grandi dimensioni per facilitare la manovrabilità della macchina durante l'utilizzo.



Regolazione della profondità della fresa per utilizzo su ogni tipologia di terreno.

400

Alimentazione	Motore	Modello	Cilindrata	Potenza	Avviamento	Codice
gasoline	Emak	K 700 H OHV	182 cm ³	5,4 HP	autoavvolgente	68369001E5

Focus accessori



Assolcatore retrofresa
Codice 69209111



Coppia ruote metalliche
Ø 370 mm
Codice L0051200



VERSIONE MOTOCOLTIVATORE

Cambio/ Velocità (km/h):

2 velocità (1 avanti + 1 retro) con ruote 4.00-8"

Velocità (km/h):

1,45 **1** 1R 2,64

Dimensioni (mm)

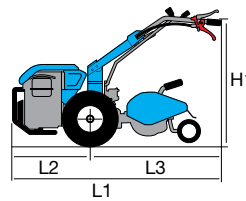

L1	1650
L2	540
L3	1110
H1	960
W1	430
W2	500

Trasmissione	ad ingranaggi in bagno d'olio
Frizione	ad innesto diretto
Stegole	regolabili verticalmente
Inversore marce	no
Differenziale	no
Freni	no
Presa di forza	sincronizzata con marcia avanti
Attacco accessori	no
Gancio di traino	no
Cofano motore	no
Peso	75 kg (macchina completa)

Motocoltivatore per uso privato

401 S



Studiato per utenti privati esigenti, in possesso di un orto domestico, questo motocoltivatore si caratterizza per la grande funzionalità e per l'eccellente combinazione di facilità d'uso e sicurezza.



Comando inserimento presa di forza direttamente sul manubrio.



Stegole orientabili verticalmente e orizzontalmente, reversibili a 180°, con dispositivo antivibrante per un maggiore confort di utilizzo.



Attacco rapido QuickFit integrato che consente all'operatore di cambiare le attrezzature senza l'utilizzo di chiavi.

401 S

Alimentazione	Motore	Modello	Cilindrata	Potenza	Avviamento	Codice
gasoline	POWERED BY HONDA	GX 160 OHV	163 cm ³	4,8 HP	autoavvolgente	68319100E5 ***
gasoline	Emak	K 800 H OHV	182 cm ³	5,7 HP	autoavvolgente	68319102E5

*** Non disponibile per il mercato italiano.

Focus accessori



Fresa Ø 280, 50-(35) cm
12 coltelli
innesto per **Quickfit**
(restringibile 35 cm con kit
L0116300)
Codice **69219110**



Assolcatore retrofresa
Codice **L0050600**



Spazzolone L 80-Ø 35 cm
Regolabile orizzontalmente
e verticalmente
Codice **L0070000**



VERSIONE MOTOCOLTIVATORE

Cambio/ Velocità (km/h):

2 velocità (1 avanti + 1 retro) con ruote 4.00-8"

Velocità (km/h): 1,18 **1** **1R** 3,07

Dimensioni (mm)

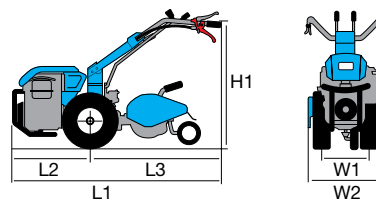

L1	1440
L2	470
L3	970
H1	230-1050
W1	380
W2	350-600

VERSIONE FALCIATRICE

Cambio/ Velocità (km/h):

2 velocità (1 avanti + 1 retro) con ruote 4.00-8"

Velocità (km/h): 3,07 **1** **1R** 1,18

Dimensioni (mm)

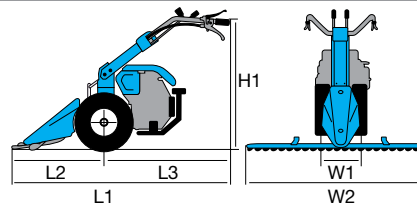

L1	1465
L2	600
L3	865
H1	345-1150
W1	380
W2	900-1117

Trasmissione	ad ingranaggi in bagno d'olio
Frizione	multidisco a secco
Stegole	regolabili verticalmente, orizzontalmente e reversibili a 180° con dispositivo antivibrante
Inversore marce	no
Differenziale	no
Freni	no
Presa di forza	indipendente a 1004 giri/min
Attacco accessori	QuickFit di serie integrato
Gancio di traino	optional
Cofano motore	no
Peso	75 kg (con motore diesel, fresa e ruote)

Accessori



401 S

Accessorio		Optional accessorio		
Frese				
 <p>Fresa Ø 280, 50-(35) cm 12 coltelli innesto per Quickfit (restringibile 35 cm con kit L0116300)</p>	<p>69219110</p>		Ruotino di sostegno	Z0020368
			Assolcatore retrofresa	L0050600
 <p>Fresa Ø 280, 60-50-(35) cm 16 coltelli innesto per Quickfit (restringibile 35 cm con kit L0116300)</p>	<p>69219107</p>		Ruotino di sostegno	Z0020368
			Assolcatore retrofresa	L0050600
Ruote gommata				
 <p>Coppia ruote gommata 4.00x8" Disco fisso Innesto rapido</p>	<p>69209020A</p>		Coppia catene da neve	L1055015
			Coppia distanziali L 100 mm	69209096
Ruote metalliche				
 <p>Coppia ruote metalliche Ø 370 mm</p>	<p>L0051200</p>			

Accessori



Accessorio		Optional accessorio			
Gancio di traino					
	Gancio di traino	L0060900			
Portattrezzi registrabile					
	Portattrezzi registrabile (necessita gancio di traino L0060900)	L0103400		Aratro monovomere	L0100000
				Assolcatore	L0103200
Movimento barra					
	Movimento eccentrico	69229091		0,92 mt Lastrone completo centrale Denti speciali	69222011
Spazzolone frontale					
	Spazzolone L 80-Ø 35 cm Regolabile orizzontalmente e verticalmente	L0070000			

Motocoltivatore per uso intensivo

405 S



Progettata per piccoli e medi appezzamenti, questa macchina coniuga, con grande efficacia e affidabilità nel tempo, prestazioni professionali e grande maneggevolezza, rendendola ideale per un'utenza di privati esigenti e agricoltori. L'ampia gamma di accessori disponibili, come frese, barre falcianti, spazzole e turboneve, è in grado di soddisfare anche le necessità di coloro che cercano una macchina multifunzione, semplice da usare e sicura.



GIUCCIARDI DESIGN



Stegole orientabili verticalmente e orizzontalmente, reversibili a 180°, con dispositivo antivibrante per un maggiore confort di utilizzo.



Il sistema EHS garantisce facilità di utilizzo, riduzione degli sforzi e massima semplificazione per l'utilizzatore.



Pratico inversore di marcia, che permette di passare velocemente alla retromarcia da qualsiasi velocità: rende la macchina maneggevole anche con la fresa e altri accessori.

405 S

Alimentazione	Motore	Modello	Cilindrata	Potenza	Avviamento	Codice
gasoline	POWERED BY HONDA	GX 200 OHV	196 cm ³	5,8 HP	autoavvolgente	68359007E5
gasoline	Emak	K 800 H OHV	182 cm ³	5,7 HP	autoavvolgente	68359004E5
diesel	Emak	K 7000 HD	349 cm ³	6,7 HP	autoavvolgente	68359016E5

Focus accessori



Fresa Ø 280, 60-50-(40) cm
16 coltelli
Attacco fisso
(restringibile 40 cm
con kit **69210259**)
Codice **69219103**



Movimento in bagno d'olio
Codice **69229096A**



Ruspa frontale L 100x40 cm
Attacco rapido
Regolabile orizzontalmente
e verticalmente
(necessita QuickFit **69212006**)
Codice **69209065**



VERSIONE MOTOCOLTIVATORE

Cambio/ Velocità (km/h):

4 velocità (2 avanti + 2 retro) con ruote 4.00-8"

Velocità (km/h):

1,05	1	1R	1,11
2,20	2	2R	2,32

Dimensioni (mm)

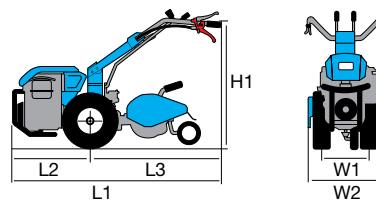

L1	1740
L2	550
L3	1190
H1	1250-300
W1	370
W2	600-400

VERSIONE FALCIATRICE

Cambio/ Velocità (km/h):

4 velocità (2 avanti + 2 retro) con ruote 4.00-8"

Velocità (km/h):

1,11	1	1R	1,05
2,32	2	2R	2,20

Dimensioni (mm)

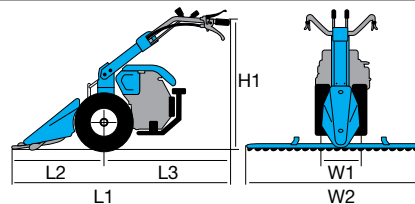

L1	1670
L2	900
L3	770
H1	1250-300
W1	370
W2	1270-950

Trasmissione	ad ingranaggi in bagno d'olio
Frizione	multidisco a secco
Stegole	regolabili verticalmente, orizzontalmente e reversibili a 180° con dispositivo antivibrante
Inversore marce	sì, con leva a manubrio
Differenziale	no
Freni	no (sì, solo in versione con motore diesel)
Presa di forza	indipendente a 973 giri/min
Attacco accessori	QuickFit (optional)
Gancio di traino	optional
Cofano motore	no
Peso	116 kg (con motore, fresa e ruote)

Accessori





















405 S

Accessorio		Optional accessorio		
Frese				
 <p>Fresa Ø 280, 60-50-(40) cm 16 coltelli Attacco fisso (restringibile 40 cm con kit 69210259)</p>	69219103	 <p>Ruotino di sostegno</p>	Z0020368	
		 <p>Assolcatore retrofresa</p>	L0009800	
 <p>Fresa Ø 280, 60-50-(40) cm 16 coltelli Quickfit incluso (restringibile 40 cm con kit 69210259)</p>	69219089	 <p>Ruotino di sostegno</p>	Z0020368	
		 <p>Assolcatore retrofresa</p>	L0009800	
Kit zavorra frontale				
 <p>Zavorra frontale 7,8 Kg</p>	69209118			
Ruote gommata				
 <p>Coppia ruote gommata 4.00x8" Disco fisso</p>	69209025B	 <p>Semiassi registrabili a vite</p>	69209105	
		 <p>Semiassi registrabili a 5 fori</p>	L0059500	
		 <p>Coppia distanziali L 50 mm</p>	69209094	
		 <p>Coppia catene da neve</p>	L1055015	
 <p>Coppia ruote gommata 4.00x10" Disco fisso</p>	69200024A	 <p>Semiassi registrabili a vite</p>	69209105	
		 <p>Semiassi registrabili a 5 fori</p>	L0059500	
		 <p>Coppia distanziali L 50 mm</p>	69209094	
		 <p>Coppia catene da neve</p>	L0021600	
 <p>Coppia ruote gommata 4.00x10" Disco registrabile</p>	69209004B	 <p>Coppia zavorre 15 Kg (non compatibili con semiassi registrabili)</p>	69209099	
		 <p>Coppia zavorre 15 Kg (compatibili con semiassi registrabili)</p>	69209075	
		 <p>Semiassi registrabili a vite</p>	69209105	
		 <p>Semiassi registrabili a 5 fori</p>	L0059500	
		 <p>Coppia distanziali L 50 mm</p>	69209094	
		 <p>Coppia catene da neve</p>	L0021600	
 <p>Coppia ruote gommata 16-6.50x8" Disco fisso</p>	69209012A	 <p>Semiassi registrabili a vite</p>	69209105	
		 <p>Semiassi registrabili a 5 fori</p>	L0059500	

Accessori



Accessorio		Optional accessorio			
Ruote metalliche					
	Coppia ruote metalliche Ø 480x100 mm	69209067		Coppia anelli allargatori L 100 mm	L0040100
				Semiassi registrabili a vite	69209105
				Semiassi registrabili a 5 fori	L0059500
				Coppia distanziali L 50 mm	69209094
Gancio di traino					
	Gancio di traino	69209072			
Movimenti e Lastroni					
	Movimento in bagno d'olio	69229096A		0,95 mt Lastrone completo centrale Denti semifitti	69229084A*
				1,15 mt Lastrone completo centrale Denti semifitti	69229085A*
				1,27 mt Lastrone completo centrale Denti semifitti	69229086A*
				0,95 mt Lastrone completo centrale Denti speciali Protezioni laterali	69229068A
				1,15 mt Lastrone completo centrale Denti speciali Protezioni laterali	69229069A
				1,27 mt Lastrone completo centrale Denti speciali Protezioni laterali	69229070A
				1,22 mt Lastrone completo centrale ESM "UNIVERSAL" (necessita kit L0058900)	69229036
				1,02 mt Lastrone completo centrale ESM "KOMUNAL" (necessita kit L0058900)	L0066900
				1,22 mt Lastrone completo centrale ESM "KOMUNAL" (necessita kit L0058900)	69229037
				Zavorra per movimento in bagno d'olio	L0105700
				Scarpe asseandane per lastrone a denti semifitti	69229098

* (consigliato l'utilizzo in combinazione alle scarpe asseandane 69229098).

Accessori



405 S

Accessorio		Optional accessorio		
Portattrezzi registrabile				
	Portattrezzi registrabile (necessita gancio di traino 69209072)	L1055001A		Aratro monovomere Z0020102
				Assolcatore Z0020133
				Scavapatate L0066400
QuickFit				
	Attacco rapido QuickFit	69212006		
Ruspa frontale				
	Ruspa frontale L 100x40 cm Attacco rapido Regolabile orizzontalmente e verticalmente (necessita QuickFit 69212006)	69209065		
Turboneve				
	Turbina L 60 cm Doppio stadio Camino regolabile Attacco rapido (necessita QuickFit 69212006)	L0026200		
Spazzolone frontale				
	Spazzolone L 100xØ 35 cm Regolabile orizzontalmente e verticalmente Attacco rapido (necessita QuickFit 69212006)	L0094200		
Trinciasarmenti a rullo				
	Trinciasarmenti L 50 cm 16 coltelli a 'Y' Freno di sicurezza integrato Flangiatura orientabile Rullo di appoggio registrabile Rotazione PTO destra Attacco rapido (necessita QuickFit 69212006)	69209119		
Sfalciaerba				
	Sfalciaerba L 65 cm Monolama Freno di sicurezza integrato Ruote pivotanti regolabili e asportabili Slitte laterali regolabili Rotazione PTO destra Attacco rapido (necessita QuickFit 69212006)	69209008		



Motocoltivatore per uso intensivo

407 S



Grazie al differenziale con leva di bloccaggio sul manubrio, che garantisce un'ottima manovrabilità e aderenza, anche su terreni difficili o in pendenza, questa macchina garantisce la facilità d'uso come punto di forza. La possibilità di utilizzare numerosi accessori per la lavorazione del terreno, per lo sfalcio dell'erba e per la manutenzione di giardini o aree urbane, la rende particolarmente versatile e adatta all'utilizzatore più esigente e all'agricoltore.



GIUCCIARDI DESIGN



Leva differenziale ed inversore sono facilmente raggiungibili ed azionabili.



Freni a comando indipendente e rotazione piantone a manubrio, facilitano le manovre sui terreni più difficili.



Attacco rapido QuickFit che consente all'operatore di cambiare le attrezzature senza l'utilizzo di chiavi.

407 S

Alimentazione	Motore	Modello	Cilindrata	Potenza	Avviamento	Codice
gasoline	POWERED by HONDA	GX 200 OHV	196 cm ³	5,8 HP	autoavvolgente	68359100E5
gasoline	POWERED by HONDA	GX 270 OHV	270 cm ³	8,4 HP	autoavvolgente	68359117E5
gasoline	Emak	K 800 H OHV	182 cm ³	5,7 HP	autoavvolgente	68359101E5 ***
gasoline	Emak	K 900 H OHV	252 cm ³	7,0 HP	autoavvolgente	68359119E5
gasoline	KOHLER	CH 270 OHV	208 cm ³	7,0 HP	autoavvolgente	68359104E5 ***
diesel	Emak	K 7000 HD	349 cm ³	6,7 HP	autoavvolgente	68359114E5

*** Non disponibile per il mercato italiano.

Focus accessori



Fresa Ø 280, 60-50-(40) cm
16 coltelli
Quickfit incluso
(restringibile 40 cm
con kit **69210259**)
Codice **69219089**



Turbina L 60 cm
Doppio stadio
Camino regolabile
Attacco rapido
(necessita QuickFit **69212006**)
Codice **L0026200**



Trinciasarmenti L 65 cm
24 coltelli a 'Y'
Freno di sicurezza integrato
Flangiatura orientabile
Rullo di appoggio registrabile
Rotazione PTO destra
Attacco rapido
(necessita QuickFit **69212006**)
Codice **L0091000**



VERSIONE MOTOCOLTIVATORE

Cambio/ Velocità (km/h):

4 velocità (2 avanti + 2 retro) con ruote 4.00-10"

Velocità (km/h):

1,20	1	1R	1,27
2,52	2	2R	2,66

Dimensioni (mm)

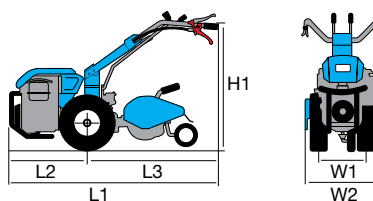

L1	1780
L2	570
L3	1210
H1	1340-470
W1	370
W2	700-400

VERSIONE FALCIATRICE

Cambio/ Velocità (km/h):

4 velocità (2 avanti + 2 retro) con ruote 4.00-10"

Velocità (km/h):

1,27	1	1R	1,20
2,66	2	2R	2,52

Dimensioni (mm)

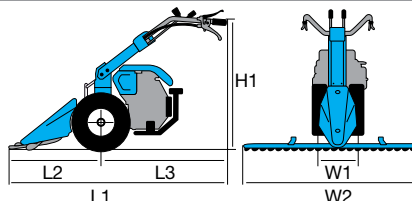











L1	1690
L2	900
L3	790
H1	1440-620
W1	370
W2	1420-950

Trasmissione	ad ingranaggi in bagno d'olio
Frizione	multidisco a secco
Stegole	regolabili verticalmente, orizzontalmente e reversibili a 180° con dispositivo antivibrante
Inversore marce	sì, con leva a manubrio
Differenziale	sì
Freni	sì
Presa di forza	indipendente a 973 giri/min
Attacco accessori	QuickFit (optional)
Gancio di traino	sì
Cofano motore	no
Peso	120 kg (con motore, fresa e ruote)

Accessori



407 S

Accessorio		Optional accessorio		
Frese				
 <p>Fresa Ø 280, 60-50-(40) cm 16 coltelli Attacco fisso (restringibile 40 cm con kit 69210259)</p>	69219103		Ruotino di sostegno	Z0020368
			Assolcatore retrofresa	L0009800
 <p>Fresa Ø 280, 60-50-(40) cm 16 coltelli Quickfit incluso (restringibile 40 cm con kit 69210259)</p>	69219089		Ruotino di sostegno	Z0020368
			Assolcatore retrofresa	L0009800
 <p>Fresa Ø 320, (80)-70-60-(50) cm 20 coltelli Quickfit incluso Ruotino di sostegno incluso (estensibile 80 cm con kit 69210231) (restringibile 50 cm con kit 69210229)</p>	69219060		Assolcatore retrofresa	L0009800
			Assolcatore retrofresa	L0009800
 <p>Fresa Ø 320, (80)-70-60-(50) cm 20 coltelli Attacco fisso Ruotino di sostegno incluso (estensibile 80 cm con kit 69210231) (restringibile 50 cm con kit 69210229)</p>	69219066		Assolcatore retrofresa	L0009800



























Accessori

Accessorio		Optional accessorio		
Ruote gommatae				
 <p>Coppia ruote gommatae 4.00x8" Disco fisso</p>	69209025B		Semiassi registrabili a vite	69209105
			Semiassi registrabili a 5 fori	L0059500
			Coppia distanziali L 50 mm	69209094
			Coppia catene da neve	L1055015
 <p>Coppia ruote gommatae 4.00x10" Disco fisso</p>	69200024A		Semiassi registrabili a vite	69209105
			Semiassi registrabili a 5 fori	L0059500
			Coppia distanziali L 50 mm	69209094
			Coppia catene da neve	L0021600
 <p>Coppia ruote gommatae 4.00x10" Disco registrabile</p>	69209004B		Coppia zavorre 15 Kg (non compatibili con semiassi registrabili)	69209099
			Coppia zavorre 15 Kg (compatibili con semiassi registrabili)	69209075
			Semiassi registrabili a vite	69209105
			Semiassi registrabili a 5 fori	L0059500
			Coppia distanziali L 50 mm	69209094
			Coppia catene da neve	L0021600
 <p>Coppia ruote gommatae 5.00x10" Disco registrabile</p>	69209003B		Coppia zavorre 15 Kg (non compatibili con semiassi registrabili)	69209099
			Coppia zavorre 15 Kg (compatibili con semiassi registrabili)	69209075
			Semiassi registrabili a vite	69209105
			Semiassi registrabili a 5 fori	L0059500
			Coppia distanziali L 50 mm	69209094
			Coppia catene da neve	L0030200
 <p>Coppia ruote gommatae 16-6.50x8" Disco fisso</p>	69209012A		Semiassi registrabili a vite	69209105
			Semiassi registrabili a 5 fori	L0059500

Accessori



407 S

Accessorio		Optional accessorio			
Ruote metalliche					
	Coppia ruote metalliche Ø 480x100 mm	69209067		Coppia anelli allargatori L 100 mm	L0040100
				Semiassi registrabili a vite	69209105
				Semiassi registrabili a 5 fori	L0059500
				Coppia distanziali L 50 mm	69209094
Portattrezzi registrabile					
	Portattrezzi registrabile	L1055001A		Aratro monovomere	Z0020102
				Assolcatore	Z0020133
				Scavapatate	L0066400
Movimenti e Lastroni					
	Movimento in bagno d'olio	69229096A		0,95 mt Lastrone completo centrale Denti semifitti	69229084A*
				1,15 mt Lastrone completo centrale Denti semifitti	69229085A*
				1,27 mt Lastrone completo centrale Denti semifitti	69229086A*
				1,40 mt Lastrone completo centrale Denti semifitti	69229087A*
				0,95 mt Lastrone completo centrale Denti speciali Protezioni laterali	69229068A
				1,15 mt Lastrone completo centrale Denti speciali Protezioni laterali	69229069A
				1,27 mt Lastrone completo centrale Denti speciali Protezioni laterali	69229070A
				1,40 mt Lastrone completo centrale Denti speciali Protezioni laterali	69229071A
				1,22 mt Lastrone completo centrale ESM "UNIVERSAL" (necessita kit L0058900)	69229036
				1,42 mt Lastrone completo centrale ESM "UNIVERSAL" (necessita kit L0058900)	69229021
				1,02 mt Lastrone completo centrale ESM "KOMUNAL" (necessita kit L0058900)	L0066900
				1,22 mt Lastrone completo centrale ESM "KOMUNAL" (necessita kit L0058900)	69229037
				1,42 mt Lastrone completo centrale ESM "KOMUNAL" (necessita kit L0058900)	69229038
				Zavorra per movimento in bagno d'olio	L0105700
	Scarpe asseandane per lastrone a denti semifitti	69229098			

* (consigliato l'utilizzo in combinazione alle scarpe asseandane 69229098).



Accessori

Accessorio		Optional accessorio		
Ruspa frontale				
	<p>Ruspa frontale L 100x40 cm Attacco rapido Regolabile orizzontalmente e verticalmente (necessita QuickFit 69212006)</p>	69209065		
Turboneve				
	<p>Turbina L 60 cm Doppio stadio Camino regolabile Attacco rapido (necessita QuickFit 69212006)</p>	L0026200		
Spazzolone frontale				
	<p>Spazzolone L 100xØ 35 cm Regolabile orizzontalmente e verticalmente Attacco rapido (necessita QuickFit 69212006)</p>	L0094200		
Trinciasarmenti a rullo				
	<p>Trinciasarmenti L 65 cm 24 coltelli a 'Y' Freno di sicurezza integrato Flangiatura orientabile Rullo di appoggio registrabile Rotazione PTO destra Attacco rapido (necessita QuickFit 69212006)</p>	L0091000		
Sfalciaerba				
	<p>Sfalciaerba L 65 cm Monolama Freno di sicurezza integrato Ruote pivotanti regolabili e asportabili Slitte laterali regolabili Rotazione PTO destra Attacco rapido (necessita QuickFit 69212006)</p>	69209008		
Rimorchio				
	<p>Rimorchio trainato per guida a stegole Dimensioni cassone 1,25x0,95 mt Profondità cassone 30 cm Ruote 145x70-8" Portata max 300 kg Freno di servizio a pedale Freno di stazionamento a mano Cassone ribaltabile Sponda posteriore ribaltabile (non omologato per circolazione stradale)</p>	L0018601		
QuickFit				
	<p>Attacco rapido QuickFit</p>	69212006		

Motocoltivatore per uso intensivo

413 S



Progettata per un'utenza professionale, con un cambio di velocità a 3 rapporti con differenziale, è in grado affrontare i lavori più impegnativi, potendo sfruttare differenti motorizzazioni. Estremamente versatile e sicura, grazie al comando facilitato di gestione frizione EHS, coniuga la robustezza alla maneggevolezza. Un'ampia gamma di accessori soddisfa le esigenze specifiche di ogni utilizzatore.



CIUCIARO DESIGN



Leva differenziale ed inversore sono facilmente raggiungibili ed azionabili.



Il sistema EHS garantisce facilità di utilizzo, riduzione degli sforzi e massima semplificazione per l'utilizzatore.



Attacco rapido QuickFit che consente all'operatore di cambiare le attrezzature senza l'utilizzo di chiavi.

413 S

Alimentazione	Motore	Modello	Cilindrata	Potenza	Avviamento	Note	Codice
gasoline	Emak	K 1100 H	302 cm ³	8,4 HP	autoavvolgente		68329237E5 ***
gasoline	POWERED by HONDA	GX 270 OHV	270 cm ³	8,4 HP	autoavvolgente		68329201E5
gasoline	POWERED by HONDA	GX 340 OHV	389 cm ³	10,7 HP	autoavvolgente		68329200E5
gasoline	KOHLER	CH 395 OHV	277 cm ³	9,5 HP	autoavvolgente		68329206E5
diesel	LOMBARDINI A KOHLER COMPANY	15LD350	349 cm ³	7,5 HP	autoavvolgente		68329226E5
diesel	KIPOR	KM 186	406 cm ³	8,5 HP	autoavvolgente		68329207EN **
diesel	Emak	K 9000 HD	441 cm ³	9,2 HP	autoavvolgente/ elettrico	batteria fornita di serie	68329235E5
diesel	LOMBARDINI A KOHLER COMPANY	15LD440	441 cm ³	10,9 HP	autoavvolgente		68329205E5
diesel	LOMBARDINI A KOHLER COMPANY	15LD440	441 cm ³	10,9 HP	autoavvolgente/ elettrico	batteria fornita di serie	68329202E5

** Disponibile fino ad esaurimento scorte.

*** Non disponibile per il mercato italiano.

Focus accessori



Fresa Ø 320, (80)-70-60-(50) cm
20 coltelli
Quickfit incluso
Ruotino di sostegno incluso
(estensibile 80 cm con kit **69210231**)
(restringibile 50 cm con kit **69210229**)
Codice **69219060**



Turbina L 60 cm
Doppio stadio
Camino regolabile
Attacco rapido
(necessita QuickFit **69212006**)
Codice **L0026200**



Trinciasarmenti L 65 cm
24 coltelli a 'Y'
Freno di sicurezza integrato
Flangiatura orientabile
Rullo di appoggio registrabile
Rotazione PTO destra
Attacco rapido
(necessita QuickFit **69212006**)
Codice **L0091000**



VERSIONE MOTOCOLTIVATORE

Cambio/ Velocità (km/h):

6 velocità (3 avanti + 3 retro) con ruote 5.00-10"

Velocità (km/h):	1,26	1	1R	1,33
	2,64	2	2R	2,79
	4,37	3	3R	4,62

Dimensioni (mm)

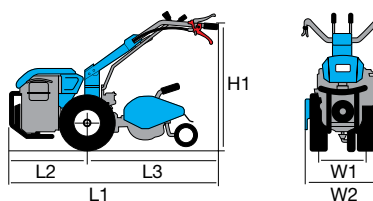

L1	1800
L2	690
L3	1110
H1	1470-630
W1	370
W2	800-400

VERSIONE FALCIATRICE

Cambio/ Velocità (km/h):

6 velocità (3 avanti + 3 retro) con ruote 5.00-10"

Velocità (km/h):	1,33	1	1R	1,26
	2,79	2	2R	2,64
	4,62	3	3R	4,37

Dimensioni (mm)

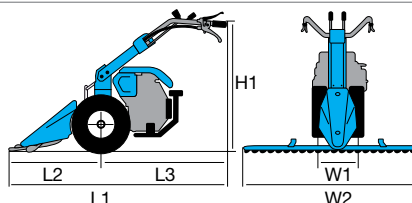









L1	1770
L2	900
L3	870
H1	1440-570
W1	370
W2	1420-950

Trasmissione	ad ingranaggi in bagno d'olio
Frizione	multidisco a secco
Stegole	regolabili verticalmente, orizzontalmente e reversibili a 180° con dispositivo antivibrante
Inversore marce	sì, con leva a manubrio
Differenziale	sì
Freni	sì
Presa di forza	indipendente a 973 giri/min
Attacco accessori	QuickFit (optional)
Gancio di traino	sì
Cofano motore	sì
Peso	130 kg (con motore diesel, fresa e ruote)

Accessori



413 S

Accessorio		Optional accessorio		
Frese				
 <p>Fresa Ø 280, 60-50-(40) cm 16 coltelli Quickfit incluso (restringibile 40 cm con kit 69210259)</p>	69219089		Ruotino di sostegno	Z0020368
			Assolcatore retrofresa	L0009800
 <p>Fresa Ø 320, (80)-70-60-(50) cm 20 coltelli Quickfit incluso Ruotino di sostegno incluso (estensibile 80 cm con kit 69210231) (restringibile 50 cm con kit 69210229)</p>	69219060		Assolcatore retrofresa	L0009800
 <p>Fresa Ø 320, 80-70-60-(50) cm 24 coltelli Quickfit incluso Ruotino di sostegno incluso (restringibile 50 cm con kit 69210229)</p>	69219055		Assolcatore retrofresa	L0009800
 <p>Fresa Ø 320, (80)-70-60-(50) cm 20 coltelli Attacco fisso Ruotino di sostegno incluso (estensibile 80 cm con kit 69210231) (restringibile 50 cm con kit 69210229)</p>	69219066		Assolcatore retrofresa	L0009800





























Accessori

Accessorio		Optional accessorio		
Ruote gommatae				
 <p>Coppia ruote gommatae 4.00x8" Disco fisso</p>	69209025B		Semiassi registrabili a vite	69209105
			Semiassi registrabili a 5 fori	L0059500
			Coppia distanziali L 50 mm	69209094
			Coppia catene da neve	L1055015
 <p>Coppia ruote gommatae 4.00x10" Disco fisso</p>	69200024A		Semiassi registrabili a vite	69209105
			Semiassi registrabili a 5 fori	L0059500
			Coppia distanziali L 50 mm	69209094
			Coppia catene da neve	L0021600
 <p>Coppia ruote gommatae 4.00x10" Disco registrabile</p>	69209004B		Coppia zavorre 15 Kg (non compatibili con semiassi registrabili)	69209099
			Coppia zavorre 15 Kg (compatibili con semiassi registrabili)	69209075
			Semiassi registrabili a vite	69209105
			Semiassi registrabili a 5 fori	L0059500
			Coppia distanziali L 50 mm	69209094
			Coppia catene da neve	L0021600
 <p>Coppia ruote gommatae 5.00x10" Disco registrabile</p>	69209003B		Coppia zavorre 15 Kg (non compatibili con semiassi registrabili)	69209099
			Coppia zavorre 15 Kg (compatibili con semiassi registrabili)	69209075
			Semiassi registrabili a vite	69209105
			Semiassi registrabili a 5 fori	L0059500
			Coppia distanziali L 50 mm	69209094
			Coppia catene da neve	L0030200
 <p>Coppia ruote gommatae 16-6.50x8" Disco fisso</p>	69209012A		Semiassi registrabili a vite	69209105
			Semiassi registrabili a 5 fori	L0059500

Accessori



413 S

Accessorio		Optional accessorio			
Ruote metalliche					
	Coppia ruote metalliche Ø 480x100 mm	69209067		Coppia anelli allargatori L 100 mm	L0040100
				Semiassi registrabili a vite	69209105
				Semiassi registrabili a 5 fori	L0059500
				Coppia distanziali L 50 mm	69209094
Portattrezzi registrabile					
	Portattrezzi registrabile	L1055001A		Aratro monovomere	Z0020102
				Aratro voltaorecchio a 180°	Z0020104
				Assolcatore	Z0020133
				Coltivatore a denti fissi	L0010200
				Scavapatate	L0066400
Movimenti e Lastroni					
	Movimento in bagno d'olio	69229096A		0,95 mt Lastrone completo centrale Denti semifitti	69229084A*
				1,15 mt Lastrone completo centrale Denti semifitti	69229085A*
				1,27 mt Lastrone completo centrale Denti semifitti	69229086A*
				1,40 mt Lastrone completo centrale Denti semifitti	69229087A*
				0,95 mt Lastrone completo centrale Denti speciali Protezioni laterali	69229068A
				1,15 mt Lastrone completo centrale Denti speciali Protezioni laterali	69229069A
				1,27 mt Lastrone completo centrale Denti speciali Protezioni laterali	69229070A
				1,40 mt Lastrone completo centrale Denti speciali Protezioni laterali	69229071A
				1,22 mt Lastrone completo centrale ESM "UNIVERSAL" (necessita kit L0058900)	69229036
				1,42 mt Lastrone completo centrale ESM "UNIVERSAL" (necessita kit L0058900)	69229021
				1,02 mt Lastrone completo centrale ESM "KOMUNAL" (necessita kit L0058900)	L0066900
				1,22 mt Lastrone completo centrale ESM "KOMUNAL" (necessita kit L0058900)	69229037
				1,42 mt Lastrone completo centrale ESM "KOMUNAL" (necessita kit L0058900)	69229038
				Zavorra per movimento in bagno d'olio	L0105700
	Scarpe asseandane per lastrone a denti semifitti	69229098			

* (consigliato l'utilizzo in combinazione alle scarpe asseandane 69229098).



Accessori

Accessorio		Optional accessorio		
Ruspa frontale				
	Ruspa frontale L 100x40 cm Attacco rapido Regolabile orizzontalmente e verticalmente (necessita QuickFit 69212006)	69209065		
Turboneve				
	Turbina L 60 cm Doppio stadio Camino regolabile Attacco rapido (necessita QuickFit 69212006)	L0026200		
Spazzolone frontale				
	Spazzolone L 100xØ 35 cm Regolabile orizzontalmente e verticalmente Attacco rapido (necessita QuickFit 69212006)	L0094200		
Trinciasarmenti a rullo				
	Trinciasarmenti L 65 cm 24 coltelli a 'Y' Freno di sicurezza integrato Flangiatura orientabile Rullo di appoggio registrabile Rotazione PTO destra Attacco rapido (necessita QuickFit 69212006)	L0091000		
Sfalciaerba				
	Sfalciaerba L 75 cm Monolama Freno di sicurezza integrato Ruote pivotanti regolabili e asportabili Slitte laterali regolabili Rotazione PTO destra Attacco rapido (necessita QuickFit 69212006)	69209007		
Rimorchio				
	Rimorchio trainato per guida a stegole Dimensioni cassone 1,25x0,95 mt Profondità cassone 30 cm Ruote 145x70-8" Portata max 300 kg Freno di servizio a pedale Freno di stazionamento a mano Cassone ribaltabile Sponda posteriore ribaltabile (non omologato per circolazione stradale)	L0018601		
QuickFit				
	Attacco rapido QuickFit	69212006		

Motocoltivatore professionale

417 S



Macchina professionale, con potenza e caratteristiche che la rendono ideale per le operazioni di sarchiatura e aratura su ogni tipo di terreno. Coniuga estrema maneggevolezza e versatilità, capacità di affrontare ogni tipo di terreno in sicurezza grazie al differenziale autobloccante unito al cambio a 5 velocità.



Il sistema EHS garantisce facilità di utilizzo, riduzione degli sforzi e massima semplificazione per l'utilizzatore.



Versione multidisco fornita di serie con cofano design Giugiaro.



Due prese di forza, una indipendente a due velocità e una sincronizzata.

417 S

Alimentazione	Motore	Modello	Cilindrata	Potenza	Avviamento	Note	Codice
gasoline	POWERED BY HONDA	GX 340 OHV	389 cm ³	10,7 HP	autoavvolgente	frizione multidisco	68339100E5
gasoline	KOHLER	CH 395 OHV	277 cm ³	9,5 HP	autoavvolgente/ elettrico	frizione multidisco/ batteria fornita di serie	68339116E5 ***
gasoline	KOHLER	CH 440 OHV	429 cm ³	14,0 HP	autoavvolgente/ elettrico	frizione monodisco/ batteria fornita di serie	68339117E5 ***
diesel	LOMBARDINI A KOHLER COMPANY	15LD440	441 cm ³	10,9 HP	autoavvolgente	frizione multidisco	68339105AE5 ***
diesel	LOMBARDINI A KOHLER COMPANY	15LD440	441 cm ³	10,9 HP	autoavvolgente/ elettrico	frizione multidisco/ batteria fornita di serie	68339101AE5 ***
diesel	KOHLER	KD 15 440	441 cm ³	10,9 HP	autoavvolgente/ elettrico	frizione monodisco/ illuminazione/ batteria fornita di serie	68339120E5 ***
diesel	LOMBARDINI A KOHLER COMPANY	3LD510	505 cm ³	12,2 HP	autoavvolgente	frizione monodisco	68339102EN
diesel	LOMBARDINI A KOHLER COMPANY	3LD510	505 cm ³	12,2 HP	elettrico	frizione monodisco/ batteria fornita di serie	68339103EN
diesel	LOMBARDINI A KOHLER COMPANY	3LD510	505 cm ³	12,2 HP	elettrico	frizione monodisco/ illuminazione/ batteria fornita di serie	68339104EN ***

*** Non disponibile per il mercato italiano.

Focus accessori



Fresa Ø 350, 80-65 cm
16 coltelli
Attacco fisso
Ruotino di sostegno incluso
Codice **69219077**



Aratro monovomere
Codice **Z0020102**



Trinciasarmenti L 80 cm
32 coltelli a 'Y'
Freno di sicurezza integrato
Flangiatura orientabile
Rullo di appoggio registrabile
Rotazione PTO sinistra
Attacco fisso



VERSIONE MOTOCOLTIVATORE

Cambio/ Velocità (km/h):

5 velocità (4 avanti + 1 retro) con ruote 6.50/80-12"

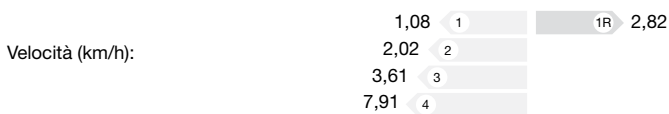

Dimensioni (mm)

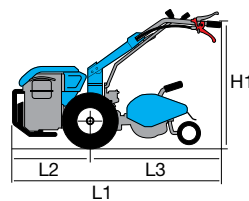

L1	2180
L2	730
L3	1450
H1	600-1300
W1	420-510
W2	600-900

VERSIONE FALCIATRICE

Cambio/ Velocità (km/h):

5 velocità (4 avanti + 1 retro) con ruote 6.50/80-12"

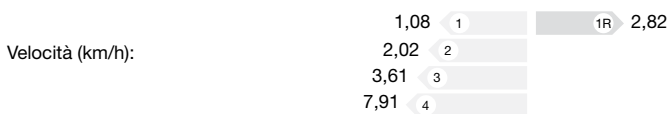

Dimensioni (mm)

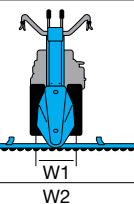
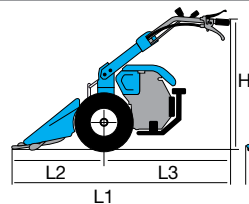

L1	2185
L2	1125
L3	1060
H1	700-1300
W1	430-490
W2	1150-1600

Trasmissione	ad ingranaggi in bagno d'olio
Frizione	multidisco a secco o monodisco
Stegole	regolabili verticalmente, orizzontalmente e reversibili a 180° con dispositivo antivibrante
Inversore marce	sì, con leva a lato del gruppo cambio
Differenziale	sì
Freni	sì
Presa di forza	2 prese di forza: una indipendente a 2 velocità (1° 540 giri/min - 2° 900 giri/min) e una sincronizzata
Attacco accessori	con flangiatura alla PTO
Gancio di traino	sì
Cofano motore	sì, con integrato porta attrezzi/contenitore batteria
Peso	250 kg (con motore diesel, fresa e ruote)

















Accessori



417 S

Accessorio	Optional accessorio			
Frese per motori < 11 HP				
 <p>Fresa Ø 320, (80)-70-60-(50) cm 20 coltelli Attacco fisso Ruotino di sostegno incluso (estensibile 80 cm con kit 69210231) (restringibile 50 cm con kit 69210229)</p>	69219070		Assolcatore retrofresa	L0009800
 <p>Fresa Ø 320, 80-70-60-(50) cm 24 coltelli Attacco fisso Ruotino di sostegno incluso (restringibile 50 cm con kit 69210229)</p>	69219068		Assolcatore retrofresa	L0009800
Frese per motori > 11 HP				
 <p>Fresa Ø 350, 80-65 cm 20 coltelli Attacco fisso Ruotino di sostegno incluso</p>	69219076		Assolcatore retrofresa	Z0020134
 <p>Fresa Ø 350, 80-65 cm 16 coltelli Attacco fisso Ruotino di sostegno incluso</p>	69219077		Assolcatore retrofresa	Z0020134



Accessorio		Optional accessorio		
Ruote gommata				
 <p>Coppia ruote gommata 5.00x10" Disco registrabile</p>	69209003B		Coppia zavorre 15 Kg (non compatibili con semiassi registrabili)	69209099
			Coppia zavorre 15 Kg (compatibili con semiassi registrabili)	69209075
			Semiassi registrabili a vite	69209105
			Semiassi registrabili a 5 fori	L0059500
			Coppia distanziali L 95 mm	69209095
			Coppia catene da neve	L0030200
 <p>Coppia ruote gommata 5.00x12" Disco registrabile</p>	69209002B		Coppia zavorre 25 Kg (compatibili con semiassi registrabili)	69209077
			Semiassi registrabili a vite	69209105
			Semiassi registrabili a 5 fori	L0059500
			Coppia distanziali L 95 mm	69209095
 <p>Coppia ruote gommata 6.5/80x12" Disco registrabile</p>	69200038B		Coppia zavorre 25 Kg (compatibili con semiassi registrabili)	69209077
			Semiassi registrabili a vite	69209105
			Semiassi registrabili a 5 fori	L0059500
			Coppia distanziali L 95 mm	69209095

Accessori



417 S

Accessorio		Optional accessorio			
Ruote metalliche					
	Coppia ruote metalliche Ø 570x125 mm	69209068		Coppia anelli allargatori L 100 mm	69209069
				Semiassi registrabili a vite	69209105
				Semiassi registrabili a 5 fori	L0059500
				Coppia distanziali L 95 mm	69209095
Portattrezzi registrabile					
	Portattrezzi registrabile	Z0020172		Aratro monovomere	Z0020102
				Aratro voltaorecchio a 180°	Z0020104
				Assolcatore	Z0020133
				Coltivatore a denti fissi (no con ruote 5.00x10")	L0010200
				Scavapatate (no con ruote 5.00x10")	L0066400
Movimenti e Lastroni					
	Movimento in bagno d'olio	L0101500A		1,15 mt Lastrone completo centrale Denti semifitti	69229085A*
				1,27 mt Lastrone completo centrale Denti semifitti	69229086A*
				1,40 mt Lastrone completo centrale Denti semifitti	69229087A*
				0,95 mt Lastrone completo centrale Denti speciali Protezioni laterali	69229068A
				1,15 mt Lastrone completo centrale Denti speciali Protezioni laterali	69229069A
				1,27 mt Lastrone completo centrale Denti speciali Protezioni laterali	69229070A
				1,40 mt Lastrone completo centrale Denti speciali Protezioni laterali	69229071A
				1,22 mt Lastrone completo centrale ESM "UNIVERSAL" (necessita kit L0058900)	69229036
				Zavorra per movimento in bagno d'olio	L0105700
	Scarpe asseandane per lastrone a denti semifitti	69229098			
Illuminazione					
	Kit faro supplementare (solo per versioni con avviamento elettrico)	69209113			

* (consigliato l'utilizzo in combinazione alle scarpe asseandane 69229098).

Accessori



Accessorio		Optional accessorio		
Trinciasarmenti a rullo				
	Trinciasarmenti L 80 cm 32 coltelli a 'Y' Freno di sicurezza integrato Flangiatura orientabile Rullo di appoggio registrabile Rotazione PTO sinistra Attacco fisso	69209120		
Sfalciaerba				
	Sfalciaerba L 75 cm Monolama Freno di sicurezza integrato Ruote pivotanti regolabili e asportabili Slitte laterali regolabili Rotazione PTO sinistra Attacco fisso	69209121		

Motocoltivatore professionale

418 S



Le caratteristiche di potenza e affidabilità lo rendono un modello ideale per gli agricoltori e i manutentori professionisti del verde. Coniuga estrema maneggevolezza e versatilità, capacità di affrontare ogni tipo di terreno in sicurezza, grazie al differenziale autobloccante unito al cambio a 5 velocità. Le potenti motorizzazioni che possono equipaggiare questo modello sono pienamente sfruttate grazie ai semiassi rinforzati, mentre i grandi riduttori sull'asse ruote permettono di trasmettere tutta la potenza mantenendo la macchina più alta da terra.



Semiassi rinforzati con riduttori integrati nel gruppo cambio per migliorare l'aderenza su terreni difficili.



Due prese di forza, una indipendente a due velocità e una sincronizzata.



Accoppiamento accessori tramite flangiatura alla presa di forza.

418 S

Alimentazione	Motore	Modello	Cilindrata	Potenza	Avviamento	Note	Codice
diesel	LOMBARDINI A KOHLER COMPANY	3LD510	505 cm ³	12,2 HP	elettrico	frizione monodisco/ illuminazione/ batteria fornita di serie	68339153AEN
diesel	LOMBARDINI A KOHLER COMPANY	25LD330	654 cm ³	16,3 HP	elettrico	frizione monodisco/ illuminazione/ batteria fornita di serie	68339154AEN
diesel	LOMBARDINI A KOHLER COMPANY	25LD425	851 cm ³	19,0 HP	elettrico	frizione monodisco/ illuminazione/ batteria fornita di serie	68339155E5 ***

*** Non disponibile per il mercato italiano.

Focus accessori



Fresa Ø 350, 80-65 cm
16 coltelli
Attacco fisso
Ruotino di sostegno
Codice **69219077**



Portattrezzi registrabile
Codice **Z0020172**



Aratro voltaorecchio a 180°
Codice **Z0020107**



VERSIONE MOTOCOLTIVATORE

Cambio/ Velocità (km/h):

5 velocità (4 avanti + 1 retro) con ruote 6.50/80-12"

Velocità (km/h):

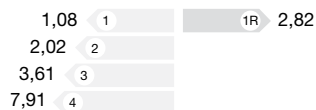

VERSIONE FALCIATRICE

Cambio/ Velocità (km/h):

5 velocità (4 avanti + 1 retro) con ruote 6.50/80-12"

Velocità (km/h):

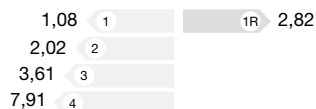

Dimensioni (mm)

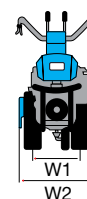
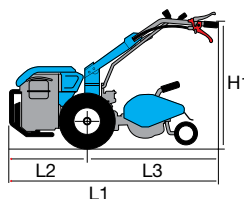

L1	2180
L2	730
L3	1450
H1	600-1300
W1	420-510
W2	600-900

Dimensioni (mm)

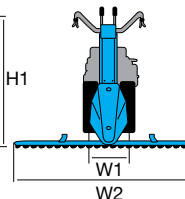
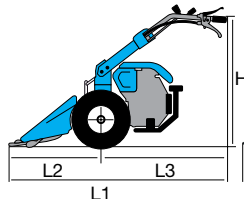

L1	2185
L2	1125
L3	1060
H1	700-1300
W1	450-510
W2	1150-1600

Trasmissione	ad ingranaggi in bagno d'olio
Frizione	monodisco a secco
Stegole	regolabili verticalmente, orizzontalmente e reversibili a 180° con dispositivo antivibrante
Inversore marce	sì, con leva a lato del gruppo cambio
Differenziale	sì
Freni	sì
Presa di forza	2 prese di forza: una indipendente a 2 velocità (1° 540 giri/min - 2° 900 giri/min) e una sincronizzata
Attacco accessori	con flangiatura alla PTO
Gancio di traino	sì
Cofano motore	sì, con integrato porta attrezzi/contenitore batteria
Peso	270 kg (con motore diesel, fresa e ruote)

Accessori



418 S

Accessorio		Optional accessorio		
Frese				
	Fresa Ø 350, 80-65 cm 20 coltelli Attacco fisso Ruotino di sostegno	69219076		Assolcatore retrofresa Z0020134
	Fresa Ø 350, 80-65 cm 16 coltelli Attacco fisso Ruotino di sostegno	69219077		Assolcatore retrofresa Z0020134
	Fresa Ø 350, 80-65 cm 20 coltelli Attacco fisso con rinvio Ruotino di sostegno (compatibile solo con ruote 6.50/80-15")	69219104		Assolcatore retrofresa Z0020134
	Fresa Ø 350, 80-65 cm 16 coltelli Attacco fisso con rinvio Ruotino di sostegno (compatibile solo con ruote 6.50/80-15")	69219105		Assolcatore retrofresa Z0020134
	Fresa Ø 350, 90-65 cm 16 coltelli Attacco fisso con rinvio Ruotino di sostegno (compatibile solo con ruote 6.50/80-15")	69219106		Assolcatore retrofresa Z0020134
Ruote gommata				
	Coppia ruote gommata 6.5/80x12" Disco registrabile	69200038B		Coppia zavorre 25 Kg (compatibili con semiassi registrabili) 69209077
				Semiassi registrabili a vite 69209105
				Semiassi registrabili a 5 fori L0059500
				Coppia distanziali L 95 mm 69209095
	Coppia ruote gommata 6.5/80x15" Disco registrabile	69209013		Coppia zavorre 25 Kg 69209077

Accessori



Accessorio	Optional accessorio
------------	---------------------

Portattrezzi registrabile

	Portattrezzi registrabile	Z0020172		Aratro monovomere	Z0020102
				Aratro voltaorecchio a 180°	Z0020107
				Assolcatore	Z0020133
				Coltivatore a denti fissi	L0010200
				Scavapatate	L0066400

Movimenti e Lastroni

	Movimento in bagno d'olio	L0101500A		1,15 mt Lastrone completo centrale Denti semifitti	69229085A*
				1,27 mt Lastrone completo centrale Denti semifitti	69229086A*
				1,40 mt Lastrone completo centrale Denti semifitti	69229087A*
				0,95 mt Lastrone completo centrale Denti speciali Protezioni laterali	69229068A
				1,27 mt Lastrone completo centrale Denti speciali Protezioni laterali	69229070A
				1,40 mt Lastrone completo centrale Denti speciali Protezioni laterali	69229071A
				1,22 mt Lastrone completo centrale ESM "UNIVERSAL" (necessita kit L0058900)	69229036
				Zavorra per movimento in bagno d'olio	L0105700
				Scarpe asseandane per lastrone a denti semifitti	69229098

Trinciasarmenti a rullo

	Trinciasarmenti L 80 cm 32 coltelli a 'Y' Freno di sicurezza integrato Flangiatura orientabile Rullo di appoggio registrabile Rotazione PTO sinistra Attacco fisso	69209120		
--	---	----------	--	--

Sfalciaerba

	Sfalciaerba L 75 cm Monolama Freno di sicurezza integrato Ruote pivotanti regolabili e asportabili Slitte laterali regolabili Rotazione PTO sinistra Attacco fisso	69209121		
--	--	----------	--	--

* (consigliato l'utilizzo in combinazione alle scarpe asseandane 69229098).

Macchine professionali per
la trinciatura di erba,
tralci e residui vari,
potenti e affidabili per
la rifinitura dei lavori nei campi.



Trinciasarmenti

PROFESSIONALE



BTS 65



BTS 80



DATI TECNICI



cambio



potenza



coltelli



larghezza di lavoro

Trinciasarmenti professionale

BTS 65



Modello estremamente performante e affidabile, progettato per le esigenze professionali degli agricoltori e dei manutentori del verde. Erba, tralci, rami e vegetazione bassa, sterpaglie e stoppie: questa macchina non si ferma davanti a nulla, assicurando una pulizia a fondo di terreni, frutteti e vigneti grazie all'efficientissimo e potente gruppo di taglio e all'ampia larghezza di lavorazione.



Frizioni di sterzo indipendenti sulle ruote motrici con bloccaggio delle ruote che permettono di manovrare la macchina con estrema facilità.



Le stegole sono regolabili in 4 posizioni verticalmente e in 5 posizioni orizzontalmente.



Ruote direzionali anteriori bloccabili per facilitare il lavoro in pendenza.

BTS 65

Alimentazione	Motore	Modello	Cilindrata	Potenza	Avviamento	Codice
gasoline	Emak	K 1100 H	302 cm ³	8,4 HP	autoavvolgente	68249008E5
gasoline	POWERED by HONDA	GX 340 OHV	389 cm ³	10,7 HP	autoavvolgente	68249007E5

Focus accessori



**Coppia ruote metalliche
+ Anelli allargamento**
Ruote metalliche Ø 410 mm
Codice **68242001**



Cambio/ Velocità (km/h):

4 velocità (3 avanti + 1 retro) con ruote 16/6.50-8"

Velocità (km/h):



Dimensioni (mm)

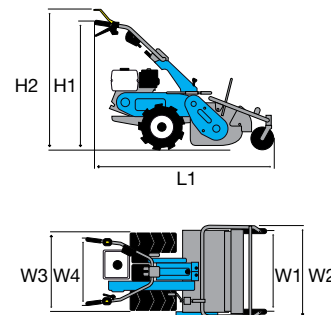

L1	1657
H1	1092
H2	1216
W1	700
W2	814
W3	670
W4	550

Trasmissione	ad ingranaggi in bagno d'olio
Frizione	a cinghia con tenditore
Sterzo	con frizioni di sterzo indipendenti e bloccaggio ruote
Stegole	regolabili verticalmente e orizzontalmente
Gruppo di taglio	rotore con 38 coltelli a 'Y'
Larghezza di lavoro	65 cm
Altezza di taglio	da 20 a 80 mm, regolabile a manovella
Freno di servizio	ad inserimento automatico
Ruote anteriori	pivottanti con bloccaggio
Ruote posteriori	16/6.50-8"
Peso	160 kg

Trinciasarmenti professionale

BTS 80



Macchina estremamente performante e affidabile, offre le stesse performance professionali del modello più piccolo, con motore più potente e larghezza di taglio superiore per risultati eccellenti in tutte le condizioni.



Rotore con coltelli a 'Y', potenti e resistenti, per tritare erba e sarmenti con piena efficienza senza timore di urti e danneggiamenti.



Leva selezione marce sul manubrio di facile inserimento.



Il freno di servizio e di stazionamento si inserisce automaticamente al disinnesto della frizione, prevenendo movimenti accidentali pericolosi.

BTS 80

Alimentazione	Motore	Modello	Cilindrata	Potenza	Avviamento	Codice
gasoline	POWERED by HONDA	GX 340 OHV	389 cm ³	10,7 HP	autoavvolgente	68249018E5

Focus accessori



**Coppia ruote metalliche
+ Anelli allargamento**
Ruote metalliche Ø 410 mm
Codice **68242001**



Cambio/ Velocità (km/h):

4 velocità (3 avanti + 1 retro) con ruote 16/6.50-8"

Velocità (km/h):



Dimensioni (mm)

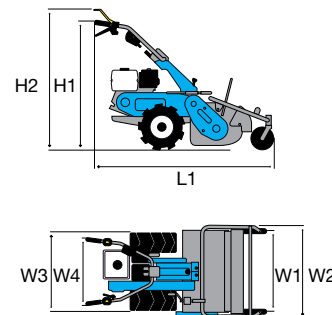

L1	1657
H1	1092
H2	1216
W1	850
W2	964
W3	670
W4	550

Trasmissione	ad ingranaggi in bagno d'olio
Frizione	a cinghia con tenditore
Sterzo	con frizioni di sterzo indipendenti e bloccaggio ruote
Stegole	regolabili verticalmente e orizzontalmente
Gruppo di taglio	rotore con 46 coltelli a 'Y'
Larghezza di lavoro	80 cm
Altezza di taglio	da 20 a 80 mm, regolabile a manovella
Freno di servizio	ad inserimento automatico
Ruote anteriori	pivottanti con bloccaggio
Ruote posteriori	16/6.50-8"
Peso	175 kg

Facilità di guida e maneggevolezza
per un taglio preciso
in ogni condizione di lavoro,
nel segno dell'affidabilità
e delle performance.



Falciatrici

PRIVATO



110



120



INTENSIVO



130 S



140



PROFESSIONALE



141



141 M



DATI TECNICI



cambio



potenza



barra falciante



blocco differenziale



inversore



freni



semiassi con riduttori

OPTIONAL



barra falciante



spazzolone



turbina



pala



trinciasarmenti



sfalciaerba

Falciatrice per uso privato

110



Predisposta per barra falciante centrale, è una macchina leggera e maneggevole progettata per soddisfare le esigenze di utenti privati. Viene usata principalmente per il taglio di erba e foraggi e per la pulizia fuori giardino.



Stegole regolabili verticalmente, permettono all'operatore di lavorare con una postura corretta.



Manubrio montato su antivibranti.



Attacco rapido QuickFit integrato che consente all'operatore di cambiare le attrezzature senza l'utilizzo di chiavi.

110

Alimentazione	Motore	Modello	Cilindrata	Potenza	Avviamento	Codice
gasoline	Emak	K 700 H OHV	182 cm ³	5,4 HP	autoavvolgente	68939001E5

Focus accessori



**Coppia ruote gommate
3.50x6"**
Disco fisso
Codice **69209107**



Movimento eccentrico
Codice **69222010**



**Lastrone completo centrale
0,92 mt**
Denti speciali
Codice **69222011**



Cambio/ Velocità (km/h):

1 velocità (1 avanti) con ruote 3.50-6"

Velocità (km/h):

2,30

1

Dimensioni (mm)

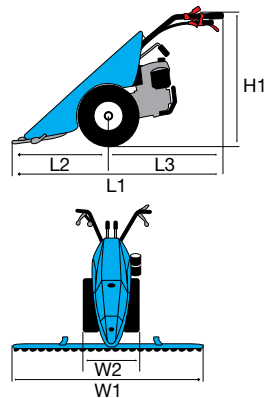

L1	1540
L2	740
L3	800
H1	990
W1	920
W2	400

Trasmissione	ad ingranaggi in bagno d'olio
Frizione	ad innesto diretto
Stegole	regolabili verticalmente con dispositivo antivibrante
Inversore marce	no
Differenziale	no
Freni	no
Presa di forza	indipendente a 1017 giri/min
Attacco accessori	QuickFit di serie
Peso	70 kg (con ruote, movimento e barra)

Falciatrici per uso privato

120



Viene usata principalmente per il taglio di erba e foraggi e per la pulizia dei campi. Particolari come le stegole regolabili verticalmente e orizzontalmente, il sistema QuickFit e la trasmissione disponibile anche con movimento in bagno d'olio denotano grande attenzione per l'operatore.



Comando inserimento presa di forza direttamente sul manubrio.



Stegole orientabili verticalmente e orizzontalmente con dispositivo antivibrante per un maggiore confort di utilizzo.



Attacco rapido QuickFit integrato che consente all'operatore di cambiare le attrezzature senza l'utilizzo di chiavi.

120

Alimentazione	Motore	Modello	Cilindrata	Potenza	Avviamento	Codice
gasoline	POWERED BY HONDA	GX 160 OHV	163 cm ³	4,8 HP	autoavvolgente	68919127X5 ***
gasoline	Emak	K 800 H OHV	182 cm ³	5,7 HP	autoavvolgente	68919131X5
gasoline	KOHLER	CH 270 OHV	208 cm ³	7,0 HP	autoavvolgente	68919126X5 ***

*** Non disponibile per il mercato italiano.

Focus accessori



Movimento eccentrico
Codice **69229091**



Lastrone completo centrale
0,92 mt
Denti speciali
Codice **69222011**



Spazzolone L 80-Ø 35 cm
Regolabile orizzontalmente
e verticalmente
Codice **L0070000**



Cambio/ Velocità (km/h):

2 velocità (1 avanti + 1 retro) con ruote 4.00-8"

Velocità (km/h): 3,07 **1** **1R** 1,18

Dimensioni (mm)

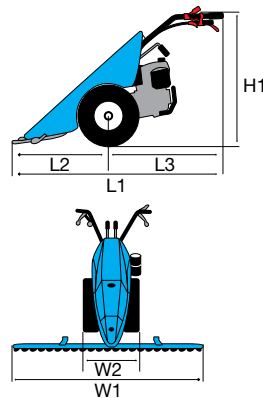

L1	1465
L2	600
L3	865
H1	1150
W1	920-1220
W2	465

Trasmissione	ad ingranaggi in bagno d'olio
Frizione	multidisco a secco
Stegole	regolabili verticalmente e orizzontalmente con dispositivo antivibrante
Inversore marce	no
Differenziale	no
Freni	no
Presa di forza	indipendente a 1004 giri/min
Attacco accessori	QuickFit di serie
Peso	80 kg (con ruote, movimento e barra)

Accessori



120

Accessorio		Optional accessorio		
Ruote gommate				
	Coppia ruote gommate 4.00x8" Disco fisso	69209025B		Coppia catene da neve L1055015
Ruote metalliche				
	Coppia ruote metalliche Ø 480x100 mm (installabili direttamente sui mozzi o in abbinamento a ruote 69209025B)	69209067		Coppia anelli allargatori L 100 mm L0040100
Movimenti e Lastroni				
	Movimento eccentrico	69229091		0,92 mt Lastrone completo centrale Denti speciali 69222011
	Movimento in bagno d'olio	69229028		0,95 mt Lastrone completo centrale Denti semifitti 69229084*
				1,15 mt Lastrone completo centrale Denti semifitti 69229085*
				0,95 mt Lastrone completo centrale Denti speciali Protezioni laterali 69229068A
				1,15 mt Lastrone completo centrale Denti speciali Protezioni laterali 69229069A
				1,22 mt Lastrone completo centrale ESM "UNIVERSAL" (necessita kit L0058900) 69229036
				1,02 mt Lastrone completo centrale ESM "KOMUNAL" (necessita kit L0058900) L0066900
				1,22 mt Lastrone completo centrale ESM "KOMUNAL" (necessita kit L0058900) 69229037
				Scarpe asseandane per lastrone a denti semifitti 69229098
				Zavorra per movimento in bagno d'olio L0105700
Spazzolone frontale				
	Spazzolone L 80-Ø 35 cm Regolabile orizzontalmente e verticalmente	L0070000		

* (consigliato l'utilizzo in combinazione alle scarpe asseandane 69229098).



Falciatrice per uso intensivo

130 S



Progettata per piccoli e medi appezzamenti, questa macchina coniuga, con grande efficacia ed affidabilità nel tempo, prestazioni professionali e grande maneggevolezza, rendendola ideale per un'utenza di privati esigenti e agricoltori. L'ampia gamma di accessori disponibili, come barre falcianti, spazzole e turboneve, è in grado di soddisfare anche le necessità di coloro che cercano una macchina multifunzione, semplice da usare e sicura.



Stegole orientabili verticalmente e orizzontalmente, con dispositivo antivibrante per un maggiore confort di utilizzo.



Il sistema EHS garantisce facilità di utilizzo, riduzione degli sforzi e massima semplificazione per l'utilizzatore.



Pratico inversore di marcia, che permette di passare velocemente alla retromarcia da qualsiasi velocità: rende la macchina maneggevole durante le varie attività di lavoro.

130 S

Alimentazione	Motore	Modello	Cilindrata	Potenza	Avviamento	Codice
gasoline	POWERED BY HONDA	GX 200 OHV	196 cm ³	5,8 HP	autoavvolgente	68949002E5
gasoline	Emak	K 800 H OHV	182 cm ³	5,7 HP	autoavvolgente	68949001E5

Focus accessori



Spazzolone L 100xØ 35 cm
Regolabile orizzontalmente
e verticalmente
Attacco rapido
Codice **L0094200**



Movimento in bagno d'olio
Codice **69229096A**



Ruspa frontale L 100x40 cm
Attacco rapido
Regolabile orizzontalmente
e verticalmente
Codice **69209065**



Cambio/ Velocità (km/h):

4 velocità (2 avanti + 2 retro) con ruote 4.00-8"

Velocità (km/h):

1,11	1	1R	1,05
2,32	2	2R	2,20

Dimensioni (mm)

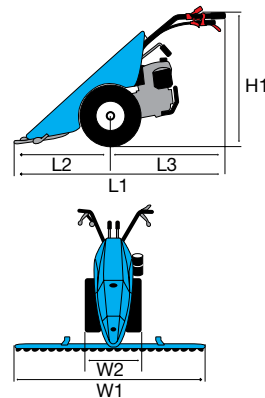



















L1	1670
L2	900
L3	770
H1	1250-300
W1	1270-950
W2	450

Trasmissione	ad ingranaggi in bagno d'olio
Frizione	conica a secco
Stegole	regolabili verticalmente, orizzontalmente con dispositivo antivibrante
Inversore marce	sì, con leva a manubrio
Differenziale	no
Freni	no
Presa di forza	indipendente a 973 giri/min
Attacco accessori	QuickFit di serie
Peso	105 kg (con ruote, movimento e barra)

Accessori



130 S

Accessorio		Optional accessorio			
Ruote gommatae					
	Coppia ruote gommatae 4.00x8" Disco fisso Innesto rapido	69209110			
			Coppia catene da neve L1055015		
	Coppia ruote gommatae 4.00x10" Disco fisso (necessita distanziali 69209112)	69200024A			
			Coppia catene da neve L0021600		
Ruote metalliche					
	Coppia ruote metalliche Ø 480x100 mm (necessita distanziali 69209112)	69209067			
			Coppia anelli allargatori L 100 mm L0040100		
Movimenti e Lastroni					
	Movimento in bagno d'olio	69229096A		0,95 mt Lastrone completo centrale Denti semifitti	69229084A*
				1,15 mt Lastrone completo centrale Denti semifitti	69229085A*
				1,27 mt Lastrone completo centrale Denti semifitti	69229086A*
				0,95 mt Lastrone completo centrale Denti speciali Protezioni laterali	69229068A
				1,15 mt Lastrone completo centrale Denti speciali Protezioni laterali	69229069A
				1,27 mt Lastrone completo centrale Denti speciali Protezioni laterali	69229070A
				1,22 mt Lastrone completo centrale ESM "UNIVERSAL" (necessita kit L0058900)	69229036
				1,02 mt Lastrone completo centrale ESM "KOMUNAL" (necessita kit L0058900)	L0066900
				1,22 mt Lastrone completo centrale ESM "KOMUNAL" (necessita kit L0058900)	69229037
				Zavorra per movimento in bagno d'olio	L0105700
				Scarpe asseandane per lastrone a denti semifitti	69229098

* (consigliato l'utilizzo in combinazione alle scarpe asseandane 69229098).



Accessori

Accessorio		Optional accessorio		
Ruspa frontale				
	<p>Ruspa frontale L 100x40 cm Attacco rapido Regolabile orizzontalmente e verticalmente</p>	69209065		
Turboneve				
	<p>Turbina L 60 cm Doppio stadio Camino regolabile Attacco rapido</p>	L0026200		
Spazzolone frontale				
	<p>Spazzolone L 100xØ 35 cm Regolabile orizzontalmente e verticalmente Attacco rapido</p>	L0094200		
Trinciasarmenti a rullo				
	<p>Trinciasarmenti L 50 cm 16 coltelli a "Y" Freno di sicurezza integrato Flangiatura orientabile Rullo di appoggio registrabile Rotazione PTO destra Attacco rapido</p>	69209119		
Sfalciaerba				
	<p>Sfalciaerba L 65 cm Monolama Freno di sicurezza integrato Ruote pivotanti regolabili e asportabili Slitte laterali regolabili Rotazione PTO destra Attacco rapido</p>	69209008		

Falciatrice per uso intensivo

140



Predisposta per barra falciante centrale, è una macchina leggera e maneggevole progettata per soddisfare le esigenze di un'utenza semi-professionale. Viene usata principalmente per il taglio di erba e foraggi e per la pulizia dei campi. Particolari come le stegole regolabili in altezza, l'invertitore rapido di marcia, il sistema QuickFit e la trasmissione disponibile anche con movimento in bagno d'olio denotano grande attenzione per l'operatore.



Invertitore rapido con leva di comando sul manubrio: consente di invertire il senso di marcia senza intervenire sulle marce.



Attacco rapido QuickFit integrato che consente all'operatore di cambiare le attrezzature senza l'utilizzo di chiavi.



Stegole orientabili verticalmente con dispositivo antivibrante per un maggiore confort di utilizzo.

140

Alimentazione	Motore	Modello	Cilindrata	Potenza	Avviamento	Codice
gasoline	POWERED BY HONDA	GX 160 OHV	163 cm ³	4,8 HP	autoavvolgente	68919051X5 ***
gasoline	Emak	K 900 H OHV	252 cm ³	7,0 HP	autoavvolgente	68919005X5 ***
gasoline	POWERED BY HONDA	GX 270 OHV	270 cm ³	8,4 HP	autoavvolgente	68919055X5
gasoline	KOHLER	CH 395 OHV	277 cm ³	9,5 HP	autoavvolgente	68919059X5

*** Non disponibile per il mercato italiano.

Focus accessori



Movimento in bagno d'olio
Codice **69229023**



Ruspa frontale L 100x40 cm
Attacco rapido
Regolabile orizzontalmente
e verticalmente
Codice **69209065**



Spazzolone L 100xØ 35 cm
Regolabile orizzontalmente
e verticalmente
Attacco rapido
Codice **L0094200**



Cambio/ Velocità (km/h):

7 velocità (4 avanti + 3 retro) con ruote 4.00-8"

Velocità (km/h):

1,05	1	1R	1,11
2,20	2	2R	2,32
3,63	3	3R	3,83
11,38	4		

Dimensioni (mm)

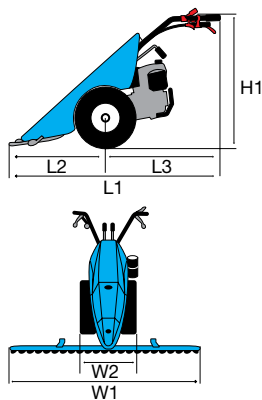

L1	1660 (1665)
L2	900 (950)
L3	760
H1	1250-400
W1	950-1450
W2	437

Trasmissione	ad ingranaggi in bagno d'olio
Frizione	multidisco a secco
Stegole	regolabili verticalmente con dispositivo antivibrante
Inversore marce	sì, con leva a manubrio
Differenziale	no
Freni	no
Presa di forza	indipendente a 973 giri/min
Attacco accessori	QuickFit di serie
Peso	115 kg (con ruote, movimento e barra)

















Accessori



140

Accessorio		Optional accessorio			
Ruote gommatae					
	Coppia ruote gommatae 4.00x8" Disco fisso	69209025B		Coppia distanziali L 50 mm	69209094
				Coppia distanziali L 130 mm Per montaggio ruote gemellate	69209097
				Coppia catene da neve	L0021600
	Coppia ruote gommatae 4.00x10" Disco fisso	69200024		Coppia distanziali L 50 mm	69209094
				Coppia distanziali L 130 mm Per montaggio ruote gemellate	69209097
				Coppia catene da neve	L0021600
	Coppia ruote gommatae 4.00x10" Disco registrabile	69209004B		Coppia distanziali L 50 mm	69209094
				Coppia distanziali L 130 mm Per montaggio ruote gemellate	69209097
				Coppia ramponi 10"	L0033800
				Coppia catene da neve	L0021600
	Coppia ruote gommatae 5.00x10" Disco registrabile	69209003B		Coppia distanziali L 50 mm (necessari per motori DIESEL)	69209094
				Coppia distanziali L 150 mm Per montaggio ruote gemellate	69209098
				Coppia catene da neve	L0030200
	Coppia ruote gommatae 16-6.50/8" Disco fisso	69209012A		Coppia distanziali L 50 mm (necessari per il montaggio)	69209094
	Coppia ruote gommatae 18-9.50/8" Disco fisso	69209104		Coppia distanziali L 100 mm (necessari per il montaggio)	69209103
Ruote metalliche					
	Coppia ruote metalliche Ø 480x100 mm	69209067		Coppia anelli allargatori L 100 mm	L0040100



Accessorio	Optional accessorio			
 <p>Movimento in bagno d'olio</p>	69229023		<p>0,95 mt Lastrone completo centrale Denti semifitti</p>	69229084A*
			<p>1,15 mt Lastrone completo centrale Denti semifitti</p>	69229085A*
			<p>1,27 mt Lastrone completo centrale Denti semifitti</p>	69229086A*
			<p>1,40 mt Lastrone completo centrale Denti semifitti</p>	69229087A*
			<p>0,95 mt Lastrone completo centrale Denti speciali Protezioni laterali</p>	69229068A
			<p>1,15 mt Lastrone completo centrale Denti speciali Protezioni laterali</p>	69229069A
			<p>1,27 mt Lastrone completo centrale Denti speciali Protezioni laterali</p>	69229070A
			<p>1,40 mt Lastrone completo centrale Denti speciali Protezioni laterali</p>	69229071A
			<p>1,22 mt Lastrone completo centrale ESM "UNIVERSAL" (necessita kit L0058900)</p>	69229036
			<p>1,42 mt Lastrone completo centrale ESM "UNIVERSAL" (necessita kit L0058900)</p>	69229021
			<p>1,02 mt Lastrone completo centrale ESM "KOMUNAL" (necessita kit L0058900)</p>	L0066900
			<p>1,22 mt Lastrone completo centrale ESM "KOMUNAL" (necessita kit L0058900)</p>	69229037
			<p>1,42 mt Lastrone completo centrale ESM "KOMUNAL" (necessita kit L0058900)</p>	69229038
			<p>Scarpe asseandane per lastrone a denti semifitti</p>	69229098
			<p>Zavorra per movimento meccanico</p>	L0105500
	<p>Zavorra per movimento in bagno d'olio</p>	L0105700		

* (consigliato l'utilizzo in combinazione alle scarpe asseandane **69229098**).

Accessori



140

Accessorio		Optional accessorio		
Ruspa frontale				
 <p>Ruspa frontale L 100x40 cm Attacco rapido Regolabile orizzontalmente e verticalmente</p>	69209065			
Turboneve				
 <p>Turbina L 60 cm Doppio stadio Camino regolabile Attacco rapido</p>	L0026200			
Spazzolone frontale				
 <p>Spazzolone L 100xØ 35 cm Regolabile orizzontalmente e verticalmente Attacco rapido</p>	L0094200			
Trinciasarmenti a rullo				
 <p>Trinciasarmenti L 65 cm 24 coltelli a "Y" Freno di sicurezza integrato Flangiatura orientabile Rullo di appoggio registrabile Rotazione PTO destra Attacco rapido</p>	L0091000			
Sfalciaerba				
 <p>Sfalciaerba L 75 cm Monolama Freno di sicurezza integrato Ruote pivotanti regolabili e asportabili Slitte laterali regolabili Rotazione PTO destra Attacco rapido</p>	69209007			



Falciatrice professionale

141



Il modello 141 completa l'offerta per l'utenza semi-professionale: si tratta di una macchina ideale per il taglio in campo aperto di erba, foraggio e attività di pulizia. Caratterizzata da un'ottima combinazione di potenza e maneggevolezza, questa falciatrice monta di serie freni a comando indipendente.



Freni a comando indipendente di serie.



Pratico inversore di marcia, che permette di passare velocemente alla retromarcia da qualsiasi velocità.



Differenziale di serie, per facilitare le manovre anche in pendenza.

141

Alimentazione	Motore	Modello	Cilindrata	Potenza	Avviamento	Codice
gasoline	Emak	K 1100 H	302 cm ³	8,4 HP	autoavvolgente	68919002X5 ***
gasoline	POWERED by HONDA	GX 270 OHV	270 cm ³	8,4 HP	autoavvolgente	68919025X5
gasoline	KOHLER	CH 395 OHV	277 cm ³	9,5 HP	autoavvolgente	68919030X5
diesel	Emak	K 7000 HD	349 cm ³	6,5 HP	autoavvolgente	68919007X5 ***
diesel	LOMBARDINI <small>by KOHLER COMPANY</small>	15LD350	349 cm ³	7,5 HP	autoavvolgente	68919022X5

*** Non disponibile per il mercato italiano.

Focus accessori



Movimento in bagno d'olio
Codice **69229023**

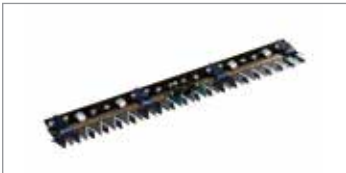

Lastrone completo centrale
1,15 mt
Denti speciali
Protezioni laterali
Codice **69229069A**



Turbina L 60 cm
Doppio stadio
Camino regolabile
Attacco rapido
Codice **L0026200**



Cambio/ Velocità (km/h):

7 velocità (4 avanti + 3 retro) con ruote 4.00-10"

Velocità (km/h):

1,20	1	1R	1,27
2,57	2	2R	2,66
4,17	3	3R	4,41
13,05	4		

Dimensioni (mm)

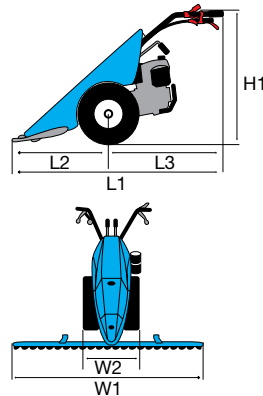

L1	1660 (1665)
L2	900 (950)
L3	760
H1	1255-405
W1	900-1600
W2	445-586

Trasmissione	ad ingranaggi in bagno d'olio
Frizione	multidisco a secco
Stegole	regolabili verticalmente con dispositivo antivibrante
Inversore marce	sì, con leva a manubrio
Differenziale	sì
Freni	sì
Presa di forza	indipendente a 973 giri/min
Attacco accessori	QuickFit di serie
Peso	135 kg (con ruote, movimento e barra)



















Accessori



141

Accessorio		Optional accessorio		
Ruote gommatae				
 <p>Coppia ruote gommatae 4.00x10" Disco fisso</p>	69200024	 <p>Coppia distanziali L 50 mm</p>	69209094	
		 <p>Coppia distanziali L 130 mm Per montaggio ruote gemellate</p>	69209097	
		 <p>Coppia catene da neve</p>	L0021600	
 <p>Coppia ruote gommatae 4.00x10" Disco registrabile</p>	69209004B	 <p>Coppia distanziali L 50 mm</p>	69209094	
		 <p>Coppia distanziali L 130 mm Per montaggio ruote gemellate</p>	69209097	
		 <p>Coppia ramponi 10"</p>	L0033800	
		 <p>Coppia catene da neve</p>	L0021600	
 <p>Coppia ruote gommatae 5.00x10" Disco registrabile</p>	69209003B	 <p>Coppia distanziali L 50 mm (necessari per motori DIESEL)</p>	69209094	
		 <p>Coppia distanziali L 150 mm Per montaggio ruote gemellate</p>	69209098	
		 <p>Coppia catene da neve</p>	L0030200	
 <p>Coppia ruote gommatae 18-9.50/8" Disco fisso</p>	69209104	 <p>Coppia distanziali L 100 mm (necessari per il montaggio)</p>	69209103	
Ruote metalliche				
 <p>Coppia ruote metalliche Ø 480x100 mm</p>	69209067	 <p>Coppia anelli allargatori L 100 mm</p>	L0040100	



Accessorio	Optional accessorio		
 <p>Movimento in bagno d'olio</p>	69229023		<p>0,95 mt Lastrone completo centrale Denti semifitti</p> <p>69229084A*</p>
			<p>1,15 mt Lastrone completo centrale Denti semifitti</p> <p>69229085A*</p>
			<p>1,27 mt Lastrone completo centrale Denti semifitti</p> <p>69229086A*</p>
			<p>1,40 mt Lastrone completo centrale Denti semifitti</p> <p>69229087A*</p>
			<p>1,60 mt Lastrone completo centrale Denti semifitti</p> <p>69229093A*</p>
			<p>0,95 mt Lastrone completo centrale Denti speciali Protezioni laterali</p> <p>69229068A</p>
			<p>1,15 mt Lastrone completo centrale Denti speciali Protezioni laterali</p> <p>69229069A</p>
			<p>1,27 mt Lastrone completo centrale Denti speciali Protezioni laterali</p> <p>69229070A</p>
			<p>1,40 mt Lastrone completo centrale Denti speciali Protezioni laterali</p> <p>69229071A</p>
			<p>1,22 mt Lastrone completo centrale ESM "UNIVERSAL" (necessita kit L0058900)</p> <p>69229036</p>
			<p>1,42 mt Lastrone completo centrale ESM "UNIVERSAL" (necessita kit L0058900)</p> <p>69229021</p>
			<p>1,02 mt Lastrone completo centrale ESM "KOMUNAL" (necessita kit L0058900)</p> <p>L0066900</p>
			<p>1,22 mt Lastrone completo centrale ESM "KOMUNAL" (necessita kit L0058900)</p> <p>69229037</p>
			<p>1,42 mt Lastrone completo centrale ESM "KOMUNAL" (necessita kit L0058900)</p> <p>69229038</p>
			<p>Scarpe asseandane per lastrone a denti semifitti</p> <p>69229098</p>
			<p>Zavorra per movimento meccanico</p> <p>L0105500</p>
	<p>Zavorra per movimento in bagno d'olio</p> <p>L0105700</p>		

* (consigliato l'utilizzo in combinazione alle scarpe asseandane 69229098).

Accessori



141

Accessorio		Optional accessorio		
Ruspa frontale				
 <p>Ruspa frontale L 100x40 cm Attacco rapido Regolabile orizzontalmente e verticalmente</p>	69209065			
Turboneve				
 <p>Turbina L 60 cm Doppio stadio Camino regolabile Attacco rapido</p>	L0026200			
Spazzolone frontale				
 <p>Spazzolone L 100xØ 35 cm Regolabile orizzontalmente e verticalmente Attacco rapido</p>	L0094200			
Trinciasarmenti a rullo				
 <p>Trinciasarmenti L 65 cm 24 coltelli a "Y" Freno di sicurezza integrato Flangiatura orientabile Rullo di appoggio registrabile Rotazione PTO destra Attacco rapido</p>	L0091000			
Sfalciaerba				
 <p>Sfalciaerba L 75 cm Monolama Freno di sicurezza integrato Ruote pivotanti regolabili e asportabili Slitte laterali regolabili Rotazione PTO destra Attacco rapido</p>	69209007			

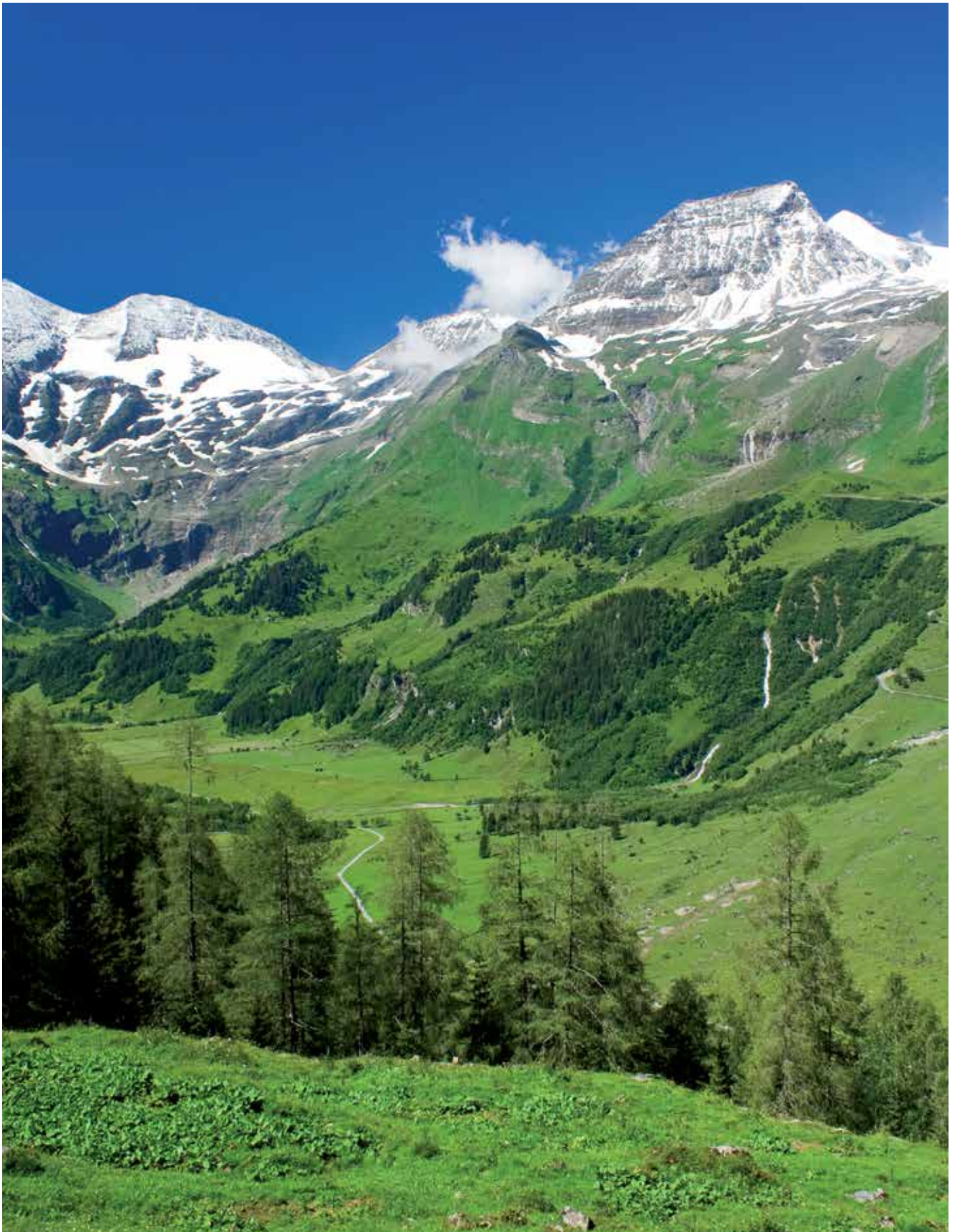

Falciatrice professionale

141 M



Modello professionale ideale per essere utilizzato in montagna, nel taglio dell'erba, fienagione e pulizia dei campi: si tratta, infatti, di una macchina potente, che si adatta bene al lavoro in campi molto inclinati.



Frizioni di sterzo a comando combinato con i freni, permettono di ruotare la macchina di 360°, con un minimo raggio di sterzata.



Semiassi con riduttori finali per migliorare l'aderenza su terreni con forte pendenza.



Freni a comando indipendente con freno di stazionamento.

141 M

Alimentazione	Motore	Modello	Cilindrata	Potenza	Avviamento	Codice
gasoline	Emak	K 1100 H	302 cm ³	8,4 HP	autoavvolgente	68919004X5 ***
gasoline	KOHLER	CH 395 OHV	277 cm ³	9,5 HP	autoavvolgente	68919083X5
diesel	Emak	K 7000 HD	349 cm ³	6,5 HP	autoavvolgente	68919009X5 ***
diesel	LOMBARDINI <small>by KOHLER COMPANY</small>	15LD350	349 cm ³	7,5 HP	autoavvolgente	68919072X5

*** Non disponibile per il mercato italiano.

Focus accessori



Movimento in bagno d'olio
Codice **69229023**



Lastrone completo centrale
1,22 mt
ESM "KOMUNAL"
(necessita kit **L0058900**)
Codice **69229037**



Coppia ruote metalliche
Ø 480x100 mm
Codice **69209067**



Cambio/ Velocità (km/h):

7 velocità (4 avanti + 3 retro) con ruote 4.00-10"

Velocità (km/h):

1,20	1	1R	1,27
2,57	2	2R	2,66
4,17	3	3R	4,41
13,05	4		

Dimensioni (mm)

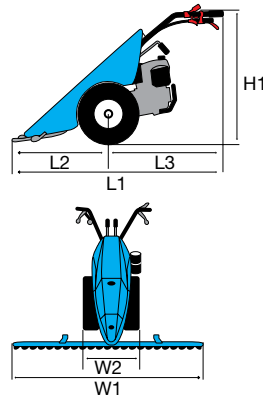

L1	1765
L2	950
L3	860
H1	1260-410
W1	1270-1620
W2	715-800

Trasmissione	ad ingranaggi in bagno d'olio
Frizione	multidisco a secco
Stegole	regolabili verticalmente con dispositivo antivibrante
Inversore marce	sì, con leva a manubrio
Differenziale	sì, con frizioni di sterzo a comando combinato con i freni
Freni	sì
Presa di forza	indipendente a 973 giri/min
Attacco accessori	QuickFit di serie
Peso	175 kg (con ruote, movimento e barra)



















Accessori



141 M

Accessorio		Optional accessorio			
Ruote gommatae					
	Coppia ruote gommatae 4.00x10" Disco fisso	69200024		Coppia distanziali L 50 mm	69209094
				Coppia distanziali L 130 mm Per montaggio ruote gemellate	69209097
				Coppia catene da neve	L0021600
	Coppia ruote gommatae 4.00x10" Disco registrabile	69209004B		Coppia distanziali L 50 mm	69209094
				Coppia distanziali L 130 mm Per montaggio ruote gemellate	69209097
				Coppia ramponi 10"	L0033800
				Coppia catene da neve	L0021600
	Coppia ruote gommatae 5.00x10" Disco registrabile	69209003B		Coppia distanziali L 50 mm (necessari per motori DIESEL)	69209094
				Coppia distanziali L 150 mm Per montaggio ruote gemellate	69209098
				Coppia catene da neve	L0030200
	Coppia ruote gommatae 5.00x10" Disco fisso	69200023A		Coppia distanziali L 150 mm Per montaggio ruote gemellate	69209098
				Coppia catene da neve	L0030200
	Coppia ruote gommatae 21-11.00/8" Disco fisso Coppia distanziali L 50 mm inclusa (69209094)	69200021A			
Ruote metalliche					
	Coppia ruote metalliche Ø 480x100 mm	69209067		Coppia anelli allargatori L 100 mm	L0040100



Accessorio	Optional accessorio	
 <p>Movimento in bagno d'olio</p>	69229023	 <p>0,95 mt Lastrone completo centrale Denti semifitti</p> <p>69229084*</p>
		 <p>1,15 mt Lastrone completo centrale Denti semifitti</p> <p>69229085*</p>
		 <p>1,27 mt Lastrone completo centrale Denti semifitti</p> <p>69229086*</p>
		 <p>1,40 mt Lastrone completo centrale Denti semifitti</p> <p>69229087*</p>
		 <p>1,60 mt Lastrone completo centrale Denti semifitti</p> <p>69229093*</p>
		 <p>0,95 mt Lastrone completo centrale Denti speciali Protezioni laterali</p> <p>69229068A</p>
		 <p>1,15 mt Lastrone completo centrale Denti speciali Protezioni laterali</p> <p>69229069A</p>
		 <p>1,27 mt Lastrone completo centrale Denti speciali Protezioni laterali</p> <p>69229070A</p>
		 <p>1,40 mt Lastrone completo centrale Denti speciali Protezioni laterali</p> <p>69229071A</p>
		 <p>1,22 mt Lastrone completo centrale ESM "UNIVERSAL" (necessita kit L0058900)</p> <p>69229036</p>
		 <p>1,42 mt Lastrone completo centrale ESM "UNIVERSAL" (necessita kit L0058900)</p> <p>69229021</p>
		 <p>1,02 mt Lastrone completo centrale ESM "KOMUNAL" (necessita kit L0058900)</p> <p>L0066900</p>
		 <p>1,22 mt Lastrone completo centrale ESM "KOMUNAL" (necessita kit L0058900)</p> <p>69229037</p>
		 <p>1,42 mt Lastrone completo centrale ESM "KOMUNAL" (necessita kit L0058900)</p> <p>69229038</p>
		 <p>Scarpe asseandane per lastrone a denti semifitti</p> <p>69229098</p>
		 <p>Zavorra per movimento meccanico</p> <p>L0105500</p>
 <p>Zavorra per movimento in bagno d'olio</p> <p>L0105700</p>		

* (consigliato l'utilizzo in combinazione alle scarpe asseandane 69229098).

Accessori



141 M

Accessorio	Optional accessorio			
Ruspa frontale				
 <p>Ruspa frontale L 100x40 cm Attacco rapido Regolabile orizzontalmente e verticalmente</p>	69209065			
Turboneve				
 <p>Turbina L 60 cm Doppio stadio Camino regolabile Attacco rapido</p>	L0026200			
Spazzolone frontale				
 <p>Spazzolone L 100xØ 35 cm Regolabile orizzontalmente e verticalmente Attacco rapido</p>	L0094200			
Trinciasarmenti a rullo				
 <p>Trinciasarmenti L 65 cm 24 coltelli a "Y" Freno di sicurezza integrato Flangiatura orientabile Rullo di appoggio registrabile Rotazione PTO destra Attacco rapido</p>	L0091000			
Sfalciaerba				
 <p>Sfalciaerba L 75 cm Monolama Freno di sicurezza integrato Ruote pivotanti regolabili e asportabili Slitte laterali regolabili Rotazione PTO destra Attacco rapido</p>	69209007			

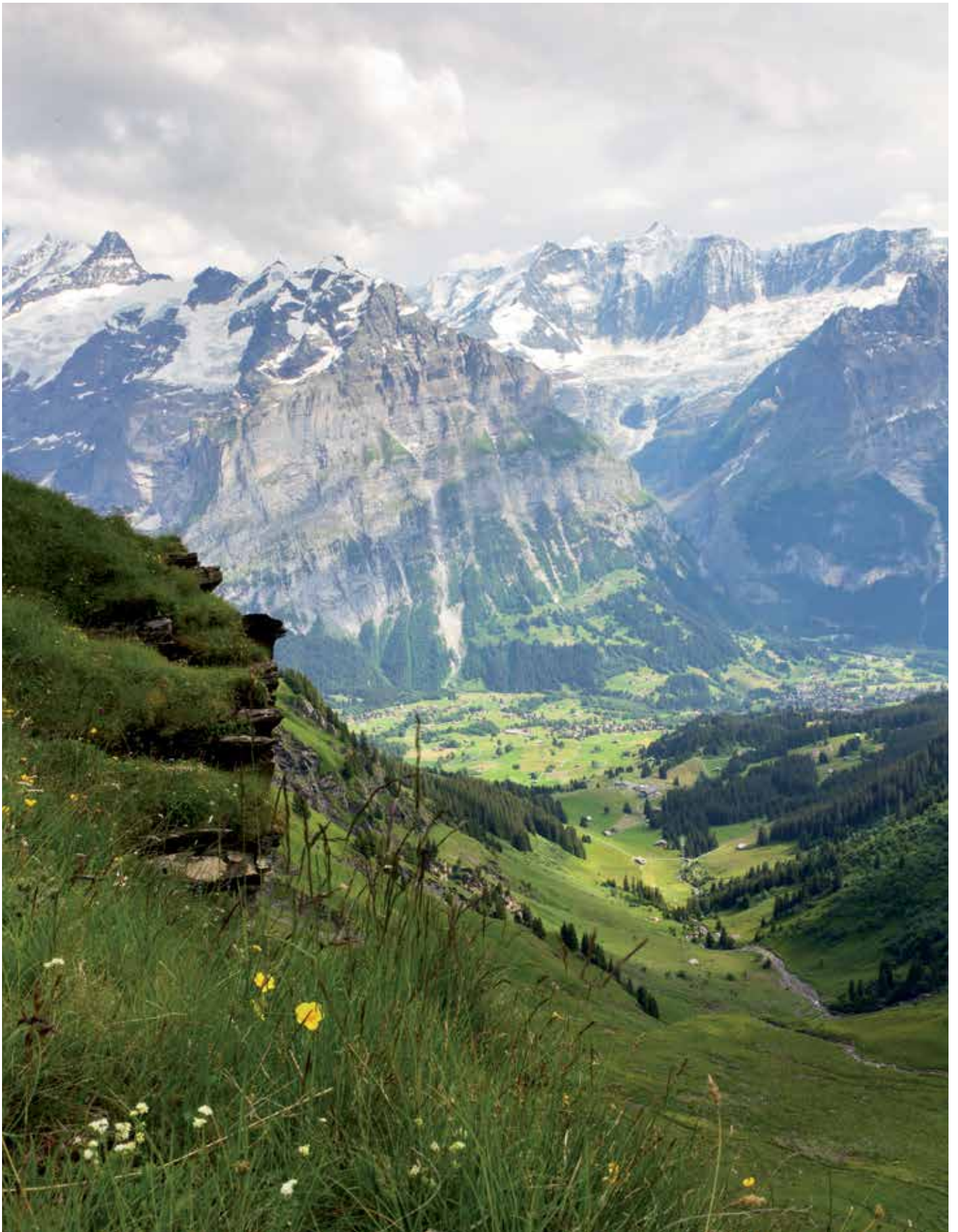

Robustezza, compattezza e maneggevolezza per trasportare su ogni tipo di terreno e senza fatica carichi pesanti e ingombranti.



Motocarriole

PRIVATO



BTR 340



INTENSIVO



BTR 450



PROFESSIONALE



BTR 550



BTR 550 D



BTR 1750 D

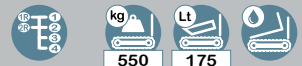

DATI TECNICI



cambio



capacità di carico



ribaltamento manuale



ribaltamento idraulico



capacità liquidi

Motocarriola per uso privato

BTR 340



Pensata per utenti privati esigenti, con le necessità di trasporto più svariate come legna da ardere, casse di frutta, oggetti ingombranti, questa macchina è estremamente pratica e maneggevole, ideale per spostamenti su ogni tipo di terreno.



Leva sul manubrio per inserimento marce.



Comando selettore delle velocità con leva.



Ribaltamento manuale con sistema di bloccaggio automatico.

BTR 340

Alimentazione	Motore	Modello	Cilindrata	Potenza	Avviamento	Codice
gasoline	HONDA	750 DOV	161 cm ³	3,8 HP	autoavvolgente	68719040
gasoline	HONDA	GCVx 170 OHC	166 cm ³	4,4 HP	autoavvolgente	68719048E5
gasoline	Emak	K 655 OHV	166 cm ³	3,9 HP	autoavvolgente	68719044E5

Focus accessori



Rialzo sponde
Codice **68722010**



Ruspa frontale 85 cm
Codice **69209071**



Cambio/ Velocità (km/h):
4 velocità (2 avanti + 2 retro)

Velocità (km/h):

1,60	1	1R	1,40
3,60	2	2R	3,40

Dimensioni (mm)

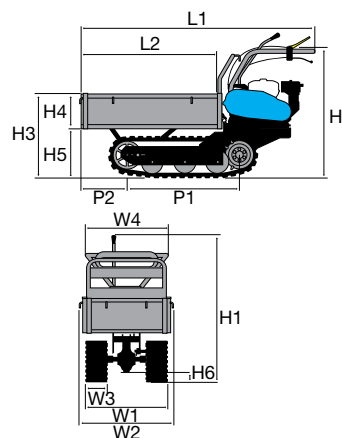

L1	1530-1665
L2	925-1060
H1	965
H2	885
H3	570
H4	240
H5	330
H6	65
W1	590
W2	603-983
W3	170
W4	520-900
P1	690
P2	415-550

Trasmissione	ad ingranaggi in bagno d'olio
Frizione	a cinghia, con disinnesto automatico al rilascio della leva di comando
Freni	con inserimento automatico al disinnesto della frizione
Portata	350 kg
Pianale di carico	espandibile
Ribaltamento	manuale
Angolo di ribaltamento	45°
Sterzo	con sbloccaggi e freni a comando indipendenti
Raggio minimo di sterzata	70 cm
Superficie di contatto cingolo	58 cm lunghezza - 17 cm larghezza
Presa di forza	no
Peso	140 kg

Motocarriola per uso intensivo

BTR 450



Progettato per soddisfare le necessità di un'utenza esigente, questo modello si distingue per maneggevolezza, robustezza e buona capacità di carico. Inoltre monta una presa di forza per l'applicazione di accessori.



Frizione a cinghia, con disinnesto automatico al rilascio della leva di comando.



Sterzo con sbloccaggi e freni a comando indipendenti.



Freni espandibili e protetti per lavori in condizioni estreme.

BTR 450

Alimentazione	Motore	Modello	Cilindrata	Potenza	Avviamento	Codice
gasoline	POWERED by HONDA	GX 160 OHV	163 cm ³	4,8 HP	autoavvolgente	68729114E5

Focus accessori



Rialzo sponde
Codice **68722003**



Ruspa frontale 85 cm
Codice **69209071**



Cambio/ Velocità (km/h):

4 velocità (3 avanti + 1 retro)

Velocità (km/h):



Dimensioni (mm)

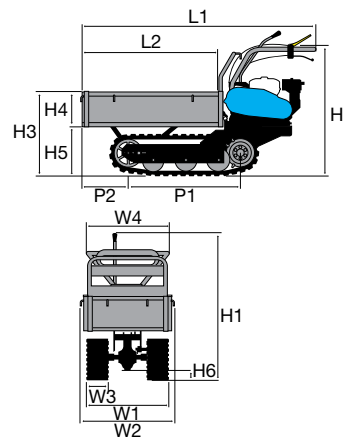

L1	1670
L2	925-1060
H1	1020
H2	900
H3	590
H4	240
H5	339
H6	70
W1	620
W2	643
W3	-
W4	560-940
P1	785
P2	330

Trasmissione	ad ingranaggi in bagno d'olio
Frizione	a cinghia, con disinnesto automatico al rilascio della leva di comando
Freni	con inserimento automatico al disinnesto della frizione
Portata	450 kg
Pianale di carico	espandibile
Ribaltamento	manuale
Angolo di ribaltamento	50°
Sterzo	con sbloccaggi e freni a comando indipendenti
Raggio minimo di sterzata	70 cm
Superficie di contatto cingolo	60 cm lunghezza - 18 cm larghezza
Presa di forza	sì, indipendente a 2100 giri/min
Peso	180 kg

Motocarriola professionale

BTR 550



Si tratta di una macchina professionale potente, robusta e compatta, ideale per muoversi su ogni tipo di terreno. Dotata di una buona capacità di carico, si distingue anche per versatilità e per i dispositivi di sicurezza con cui è equipaggiata.



Presenza di forza indipendente a 2.100 g/min.



Sterzo con sbloccaggi e freni a comando indipendenti.



Pianale di carico espandibile che permette di trasportare anche i carichi più voluminosi.

BTR 550

Alimentazione	Motore	Modello	Cilindrata	Potenza	Avviamento	Codice
gasoline	POWERED by HONDA	GX 160 OHV	163 cm ³	4,8 HP	autoavvolgente	68729118E5

Focus accessori



Rialzo sponde
Codice **68722004**



Ruspa frontale 85 cm
Codice **69209071**



Cambio/ Velocità (km/h): 6 velocità (4 avanti + 2 retro)

Velocità (km/h):

1,88	1	1R	1,86
3,16	2	2R	3,13
4,13	3		
7,00	4		

Dimensioni (mm)

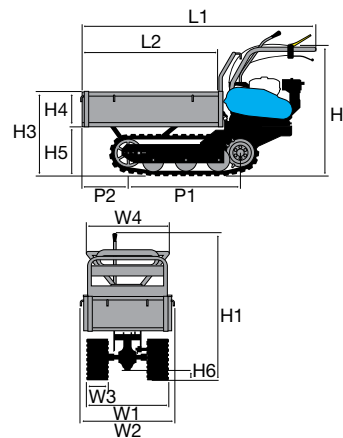

L1	1745
L2	1000-1180
H1	1020
H2	900
H3	590
H4	240
H5	339
H6	70
W1	620
W2	733
W3	-
W4	650-1100
P1	785
P2	405

Trasmissione	ad ingranaggi in bagno d'olio
Frizione	a cinghia, con disinnesto automatico al rilascio della leva di comando
Freni	con inserimento automatico al disinnesto della frizione
Portata	550 kg
Pianale di carico	espandibile
Ribaltamento	manuale
Angolo di ribaltamento	50°
Sterzo	con sbloccaggi e freni a comando indipendenti
Raggio minimo di sterzata	70 cm
Superficie di contatto cingolo	60 cm lunghezza - 18 cm larghezza
Presa di forza	sì, indipendente a 2100 giri/min
Peso	200 kg

Motocarriola professionale

BTR 550 D



Modello professionale che abbina potenza, maneggevolezza e capacità di carico. Si presta sia all'uso in campo agricolo che in capo edile. Il ribaltamento è idraulico per facilitare al massimo l'operatore durante le fasi di movimentazione dei materiali.



Distributore a leva per comando ribaltamento idraulico.



Sterzo con sbloccaggi e freni a comando indipendenti.



Freni espandibili e protetti per lavori in condizioni estreme.

BTR 550 D

Alimentazione	Motore	Modello	Cilindrata	Potenza	Avviamento	Codice
gasoline	POWERED by HONDA	GX 160 OHV	163 cm ³	4,8 HP	autoavvolgente	68729128E5

Focus accessori



Rialzo sponde
Codice **68722004**



Ruspa frontale 85 cm
Codice **69209071**



Cambio/ Velocità (km/h): 6 velocità (4 avanti + 2 retro)

Velocità (km/h):

1,88	1	1R	1,86
3,16	2	2R	3,13
4,13	3		
7,00	4		

Dimensioni (mm)

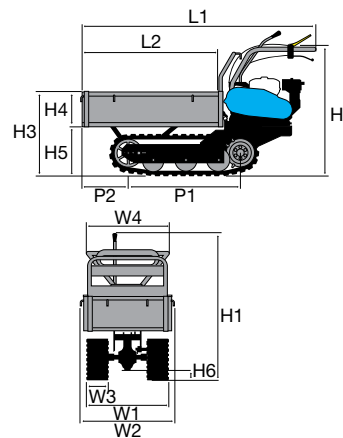

L1	1745
L2	1000-1180
H1	1020
H2	900
H3	590
H4	240
H5	339
H6	70
W1	620
W2	733
W3	-
W4	650-1100
P1	785
P2	405

Trasmissione	ad ingranaggi in bagno d'olio
Frizione	a cinghia, con disinnesto automatico al rilascio della leva di comando
Freni	con inserimento automatico al disinnesto della frizione
Portata	550 kg
Pianale di carico	espandibile
Ribaltamento	idraulico
Angolo di ribaltamento	50°
Sterzo	con sbloccaggi e freni a comando indipendenti
Raggio minimo di sterzata	70 cm
Superficie di contatto cingolo	60 cm lunghezza - 18 cm larghezza
Presa di forza	sì, indipendente a 2100 giri/min
Peso	215 kg

Motocarriola professionale

BTR 1750 D



Pensata per un'utenza professionale, è una macchina modello dumper, con cassone ribaltabile idraulicamente ideale per il trasporto di legna, frutta, pietrame, sabbia o altri materiali edili. Il notevole angolo di ribaltamento - 60° - soddisfa le esigenze di chi deve creare mucchi o cataste. Adatto ad ogni tipo di terreno, anche in pendenza, questo transporter ha un raggio di sterzata ridotto, risultando così facile da maneggiare.



Distributore a leva per comando ribaltamento idraulico.



Pianale di carico di tipo dumper con controltaio per angolo di ribaltamento a 60°.



Cingoli in gomma dura di 180 mm di larghezza: garantiscono un'ottima aderenza su ogni tipo di terreno.

BTR 1750 D

Alimentazione	Motore	Modello	Cilindrata	Potenza	Avviamento	Codice
gasoline	POWERED by HONDA	GX 160 OHV	163 cm ³	4,8 HP	autoavvolgente	68729122E5

Focus accessori



Ruspa frontale 85 cm
Codice **69209071**



Pianale di carico espandibile
portata 550 kg
Codice **68722017**



Cambio/ Velocità (km/h): 6 velocità (4 avanti + 2 retro)

Velocità (km/h):

1,88	1	1R	1,86
3,16	2	2R	3,13
4,13	3		
7,00	4		

Dimensioni (mm)

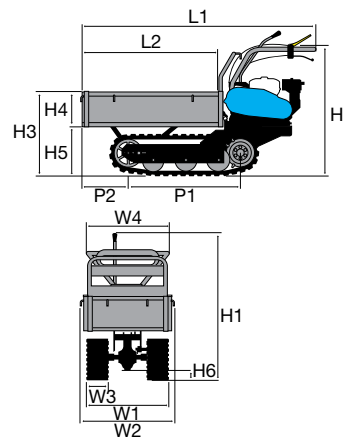

L1	1575
L2	915
H1	1020
H2	900
H3	515-725
H4	405
H5	320
H6	70
W1	622
W2	622
W3	-
W4	620
P1	785
P2	265

Trasmissione	ad ingranaggi in bagno d'olio
Frizione	a cinghia, con disinnesto automatico al rilascio della leva di comando
Freni	con inserimento automatico al disinnesto della frizione
Portata	550 kg - 175 L
Pianale di carico	fisso
Ribaltamento	idraulico
Angolo di ribaltamento	60°
Sterzo	con sbloccaggi e freni a comando indipendenti
Raggio minimo di sterzata	70 cm
Superficie di contatto cingolo	60 cm lunghezza - 18 cm larghezza
Presa di forza	sì, indipendente a 2100 giri/min
Peso	215 kg





Dati e figure del catalogo non sono vincolanti per le caratteristiche dei materiali forniti in quanto i prodotti sono soggetti a continui miglioramenti tecnici. I dati riguardanti il pratico impiego dell'equipaggiamento e quelli delle caratteristiche tecniche, così come descritti in questo catalogo, possono subire variazioni senza preavviso.

I dati di potenza dei motori si riferiscono ai valori dichiarati da ciascun costruttore e sono calcolati secondo specifici standard di misura (come SAE J1940, SAE J1349, ISO 1585), con riserva di modifica senza preavviso.

Alcuni articoli non sono disponibili in tutti i Paesi o sono disponibili solo su richiesta.





#100 years



Con riserva di modifiche. Alcuni modelli sono disponibili solo in alcuni mercati. - Cod. 3185001L - 2019



It's an **Emak S.p.A.** trademark
42011 Bagnolo in Piano (RE) Italy
www.mybertolini.it

 www.facebook.com/BertoliniItalia
 www.instagram.com/BertoliniItalia